



Article No	:	
Version	:	06.23
Prepared By	:	
Checked By	:	

## K-OD SERIS LED MINI WALL PACK



### VARIANTS

Wattage	Product Code	Operating Temperature
20W	KLSN-MWP09-20WBMSA1-BRP50	-40°C To +45°C

### APPLICATIONS

- Building perimeters
- Loading docks
- Parking areas
- Walkways
- Entrances
- Stairways
- Pathways

Upgrade your lighting with Krut LED's Mini Wall Pack LED lights. These compact and versatile fixtures deliver powerful illumination, making them perfect for various applications. Whether it's illuminating building perimeters, walkways, or entrances, our Mini Wall Pack LED lights offer exceptional energy efficiency and durability. With their sleek design and easy installation, they seamlessly blend into any architectural setting while providing bright and reliable lighting. Trust Krut LED for efficient and long-lasting Mini Wall Pack LED lights that elevate your outdoor spaces. Illuminate with confidence!

### FEATURES

- Durable construction for long-lasting performance.
- Sleek design seamlessly integrates into any setting.
- Reliable lighting for enhanced safety and visibility.
- Powerful illumination for various applications.
- Energy-efficient and cost-effective operation.
- Compact and versatile lighting solution.
- Easy installation for hassle-free setup.



WARRANTY



CRI



RATED LIFE



Article No	:	
Version	:	06.23
Prepared By	:	
Checked By	:	

## TECH SPECS

<b>Wattage</b>	<b>20W</b>
<b>Input Voltage Range</b>	120-277 VAC
<b>Input Frequency</b>	50/60Hz
<b>Power Factor</b>	> 0.9
<b>THDA</b>	≤20%
<b>Dimming</b>	0-10V
<b>Minimum Dimming</b>	0%
<b>Driver Type (CC/CV)</b>	CC
<b>Surge Projection (CM)</b>	2.5kV
<b>Surge Projection (DM)</b>	2.5kV
<b>Driver Output Voltage</b>	77.4V
<b>Driver Output Current</b>	245mA

## OPTICAL PARAMETERS

<b>Wattage</b>	<b>20W</b>
<b>Total Lumens (Min)</b>	2817LM
<b>Lumens Efficiency (Min)</b>	132LM/W
<b>Product CCT</b>	5000K
<b>CCT Range</b>	5028K ± 283
<b>Product CRI</b>	> 80 Ra
<b>Product Beam Angle</b>	100 Degree

## MECHANICAL PARAMETERS

<b>Wattage</b>	<b>20W</b>
<b>Product Dim. (mm)</b>	128 X 70 X 209
<b>Ingress Protection</b>	IP65
<b>IK Protection</b>	IK08
<b>Housing Type</b>	Die-cast aluminum
<b>Housing Weight</b>	NA
<b>Product Net Weight</b>	0.7KG

## DIMENSIONS

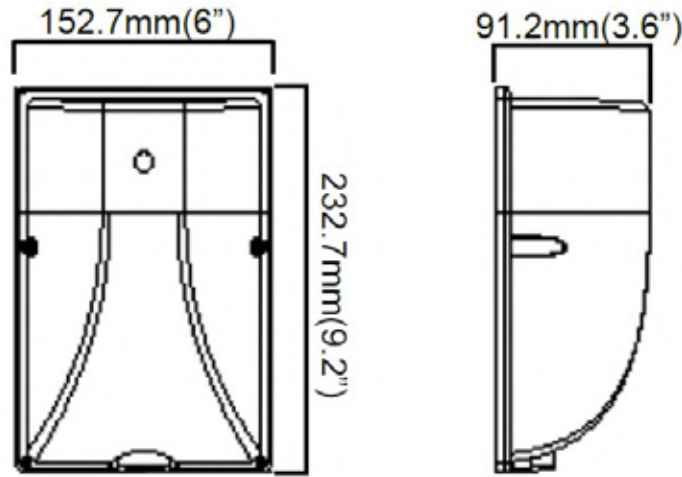

Photocell



## SHIPPING

<b>Wattage</b>	<b>20W</b>
<b>Product Dim. (in)</b>	5.04 X 2.76 X 8.23
<b>Case Lot</b>	10
<b>Master Carton Dim. (in)</b>	16.42 X 11.22 X 9.41
<b>Master Carton Weight(lbs)</b>	16.53

## INSTALLATION GUIDE

### Installation I:

1. Turn off the power

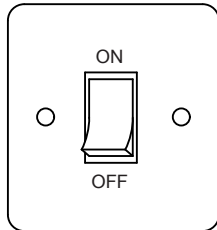

2. Remove the rubber plug and loosen 4 screws

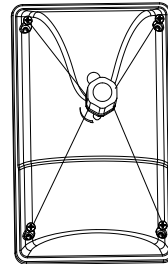

3. Remove the 1/2 end cap

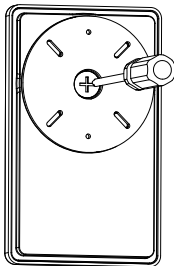

4. Peel off the yellow sticker and paste it on the round area of the bottom plate

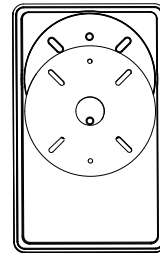

5. Fix the bottom plate on the round plate

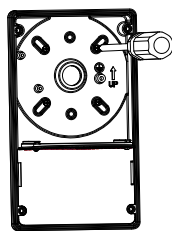

6. Make wiring connection and make sure the good protection

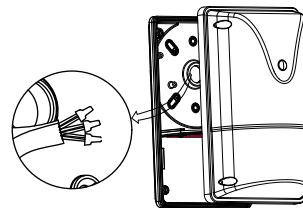

7. Fix the fixture by 4 screws, block up the two holes with rubber plugs

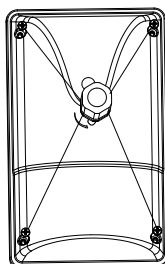

8. Make sure good wiring and screws fastening, then turn on the power

