

FLEXI FLOOD LIGHT INSTRUCTIONS

Cautions:

1. Do not use an electric generator to test LED fixtures.
2. Please abide by related country, regional and local law and regulations when install this fixture.
3. Please turn off the power before installation or maintenance.
4. Proper earth grounding is required to ensure safety.

Notice:

1. To avoid possibility of electrical shock or fire, the installation personnel must have professional electric knowledge.
2. Please wear gloves to avoid injury before installation.
3. If any smoke or spark of the wire happened, please turn off the power immediately and notify relevant personnel.

Attention:

1. Please check if there is any damage during shipping. If so, please contact manufacturer timely.
2. Please read the installation instruction carefully to check whether all the accessories are complete. After confirmation, then install the fixture according to installation steps.

Instructions:

1. This product has dimming function.
2. 2 dimming functions are available in this LED light:
(1) Constant current can be achieved by 0-10VDC dimming ..
(2) Variation of resistance unit dimming(Please choose the appropriate dimming way according to your needs. You can also choose not to use this function).
3. Choose the wire connection ways, dimming ways and installation ways according to your needs and the led fixture purchased.

Wiring Diagram:

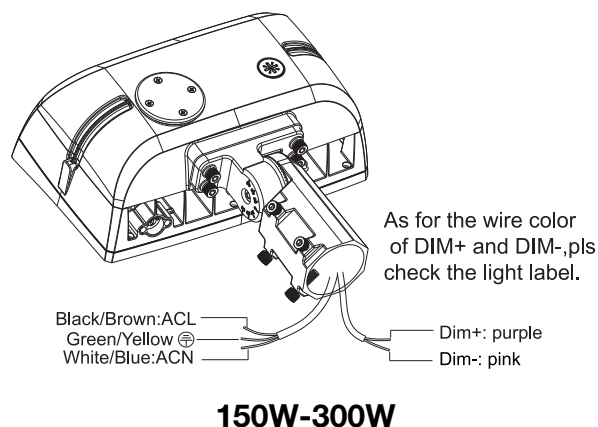
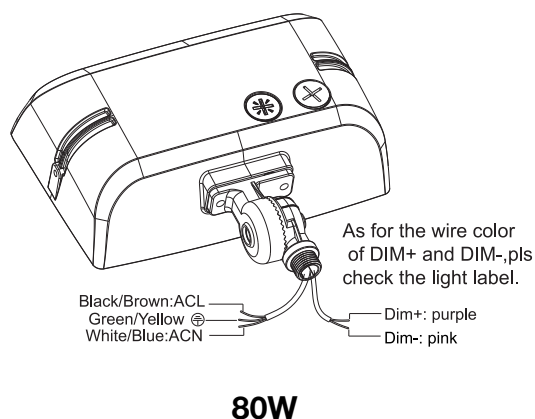

*Pictures and diagrams in this IM are for illustrative purpose only.

INSTALLATION GUIDE FOR FLEXI FLOOD LIGHT

Standard Mounting Options & Installation Instructions

Each fixture includes one standard mounting bracket based on the selected SKU. Follow the installation instructions for your mounting type.

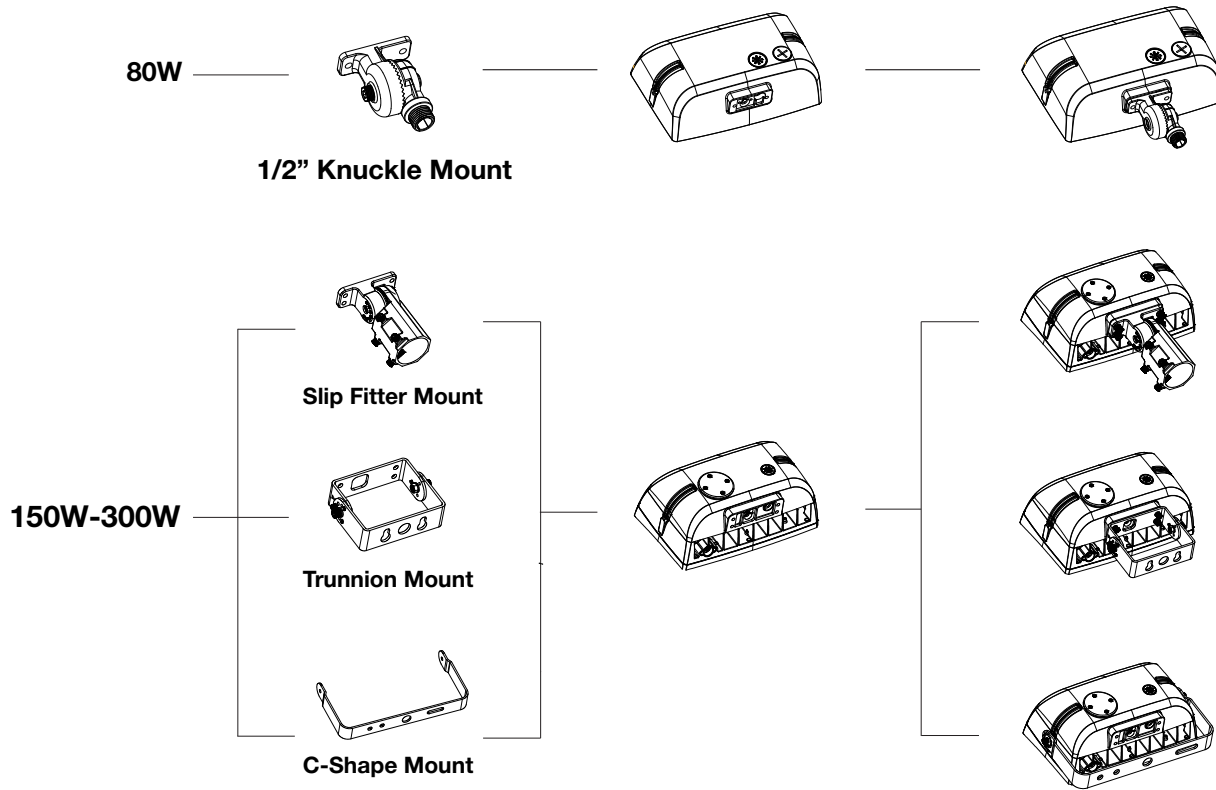

Installation 1: Slip Fitter Mount

1.1 Installed with 1/2 Knuckle Mount (suitable for 80W)

Step 1: Take the fixture out of package;

Step 2: Match the hole of rubber mat with bracket, pass wire through and fix it with screws(Watch out not to scratch the wire);(figure 1.1)

Step 3: Pass the wire through from the other bracket and fix it with screws.(Watch out not to scratch the wire);(figure1.2)

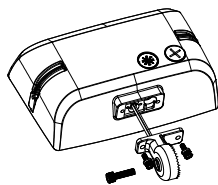

figure 1.1

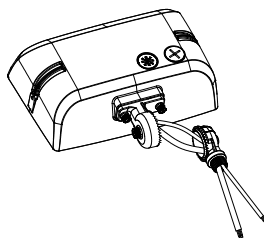

figure 1.2

*Pictures and diagrams in this IM are for illustrative purpose only.

INSTALLATION GUIDE FOR FLEXI FLOOD LIGHT

1.2 Installed with whole fixture (suitable for 80W)

- Step 1: Take the fixture out of package;
- Step 2: Finish the wire connection according to the right mode of connection (pay attention to positive wire, negative wire, and ground wire), (figure 1.3).and then put wire into lamp pole; (figure 1.4)
- Step 3: Loosen screws; Adjust fixture angles as per actual demands and tighten screws later; Angles of the fixture is adjustable(pass the bracket through mounting surface, fix it with screws, then connect the wires as per proper wiring requirements.)(figure 1.5)

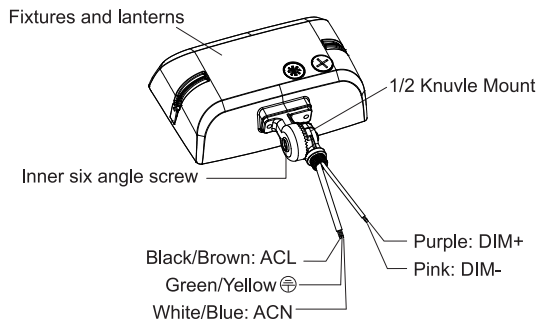

figure 1.3

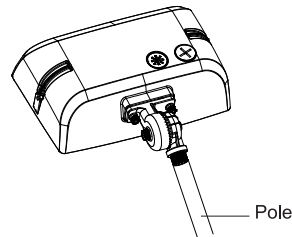

figure 1.4

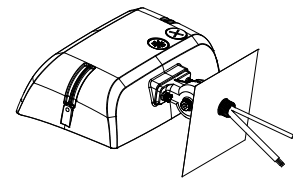

figure 1.5

Installation 2: Slip Fitter Mount

2.1 Installed with Slip Fitter Mount (suitable for 150W & 300W)

- Step 1: Take the fixture out of package;
- Step 2: Pass the rubber wire through the mounting head of the bracket and secure it with an inner hexagon screw.(Watch out not to scratch the wire); (figure 2.1)
- Step 3: Run the rubber wire through the other holder and tighten it with the hexagon socket screw. (Watch out not to scratch the wire). (figure 2.2)

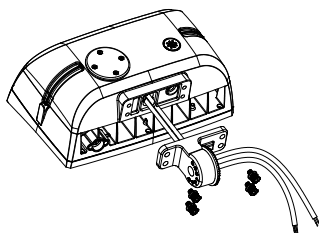

figure 2.1

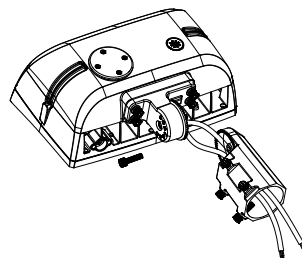

figure 2.2

*Pictures and diagrams in this IM are for illustrative purpose only.

INSTALLATION GUIDE FOR FLEXI FLOOD LIGHT

2.2 Installed with whole fixture (suitable for 150W & 300W)

Step 1: Take the fixture out of package;

Step 2: Finish the wire connection according to the right mode of connection (pay attention to positive wire, negative wire, and ground wire), and then put wire into lamp pole;(figure 2.3)

Step 3: Loosen screws; Adjust fixture angles as per actual demands and tighten screws later; Angles of the fixture is adjustable (pass the bracket through mounting surface, fix it with screws, then connect the wires as per proper wiring requirements.) (figure 2.4)

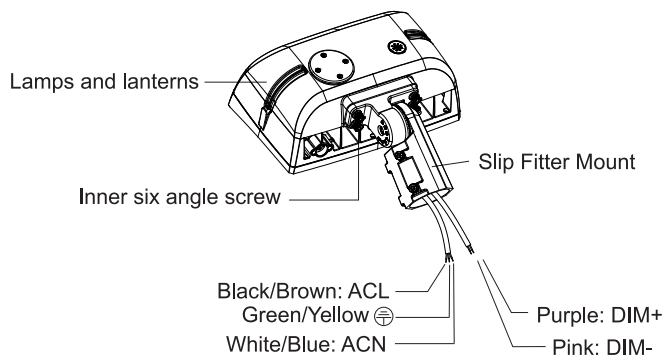

figure 2.3

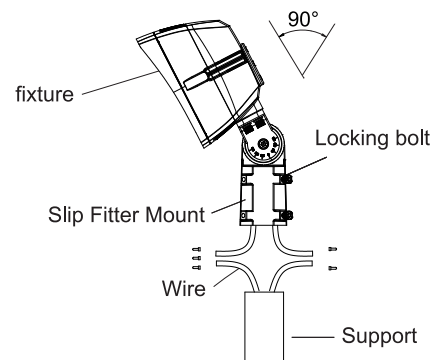

figure 2.4

3.1 Installed with C - Shape Mount(suitable for 150W & 300W)

Step 1: Take the lamp out of package;(figure 3.1)

Step 2: Tighten the brackets and screws.(figure 3.2)

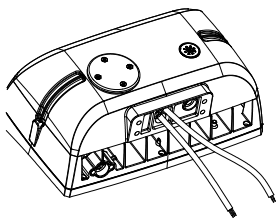

figure 3.1

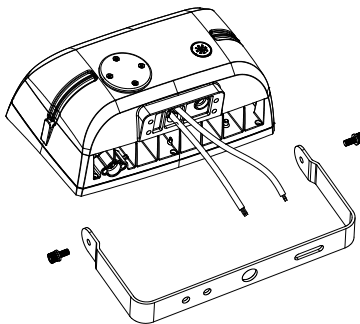

figure 3.2

*Pictures and diagrams in this IM are for illustrative purpose only.

INSTALLATION GUIDE FOR FLEXI FLOOD LIGHT

3.2 Installed with whole fixture (suitable for 150W & 300W)

Step 1: Take the fixture out of package;

Step 2: Finish the wire connection according to the right mode of connection (pay attention to positive wire, negative wire, and ground wire). (figure 3.3)

Step 3: Loosen screw; Adjust fixture angles as per actual demands and tighten screws later. (figure 3.4), Tips: Angles of the fixture is adjustable.

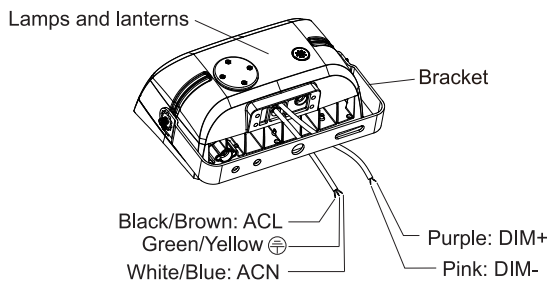

figure 3.3

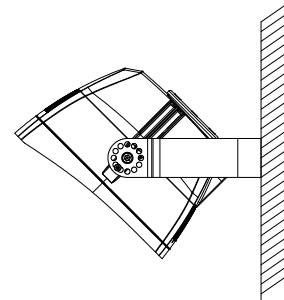

figure 3.4

Installation 4: Trunnion Mount

4.1 Installed with Trunnion Mount (suitable for 150W & 300W)

Step 1: Take the lamp out of package; (figure 4.1)

Step 2: Tighten the brackets and screws. (figure 4.2)

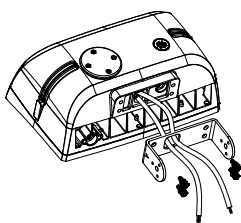

figure 4.1

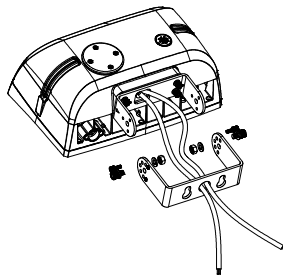

figure 4.2

4.2 Installed with whole fixture (suitable for 150W & 300W)

Step 1: Take the fixture out of package;

Step 2: Finish the wire connection according to the right mode of connection (pay attention to positive wire, negative wire, and ground wire). (figure 4.3)

Step 3: Loosen screw; Adjust fixture angles as per actual demands and tighten screws later. (figure 4.4), Tips: Angles of the fixture is adjustable.

*Pictures and diagrams in this IM are for illustrative purpose only.

INSTALLATION GUIDE FOR FLEXI FLOOD LIGHT

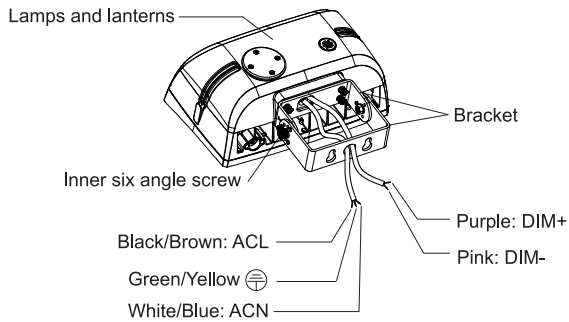

figure 4.3

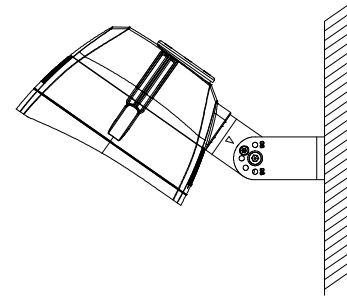

figure 4.4

Installation 5: Instructions for Photocell(suitable to 150W & 300W)

Attention:

1. The photocell hole should be blocked by a cover if the fixture doesn't come with an AC photocell receptacle.(Figure 5.1)
2. When it comes with an AC photocell receptacle on the back of the fixture, install the photocell or shorting cap according to whether the photocell function is needed or not. (Figure 5.2)

Standard wire:

L/live wire: Black/Brown;

N/null wire: White/Blue;

Ground wire: Green/Yellow-green.

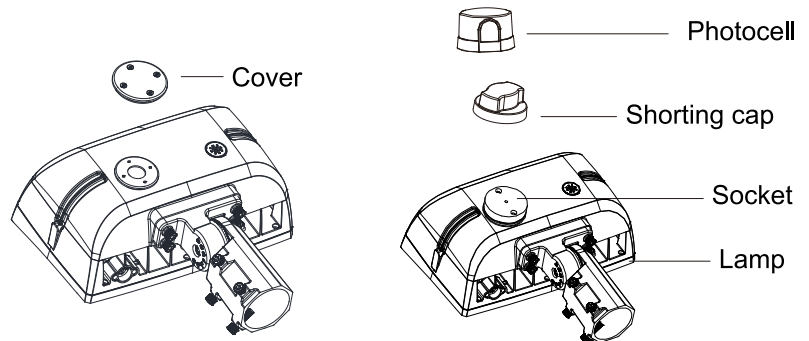

figure 5.1

figure 5.2

Installation 6: Function adjustment

Step 1: Open the metal plug and plastic plug counterclockwise with a screwdriver. (figure 6.1)

Step 2: Then slide the switch up and down to adjust the power controller, CCT controller or photocell controller in your demand. (figure 6.1)

*Pictures and diagrams in this IM are for illustrative purpose only.

INSTALLATION GUIDE FOR FLEXI FLOOD LIGHT

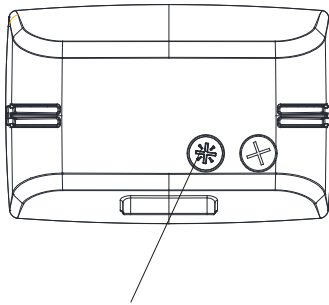
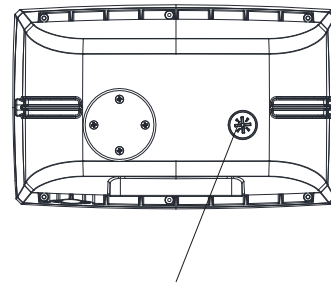

figure 6.1

photocell and power and color temperature controller



photocell and power and color temperature controller

Step 3: After adjusting the required control function (figure 6.2), tighten the metal plug and the plastic plug clockwise. (figure 6.3)

The actual power depends on the actual object, the figure is for reference only

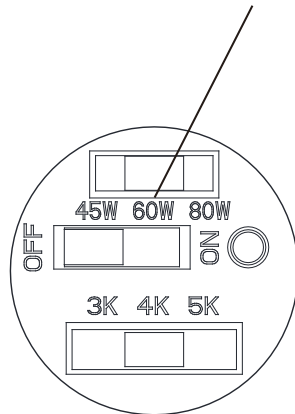

photocell and power and color temperature controller

figure 6.2

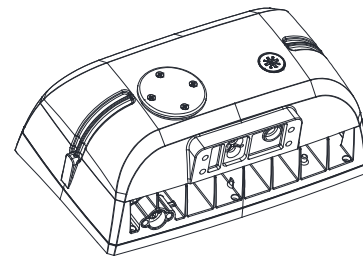
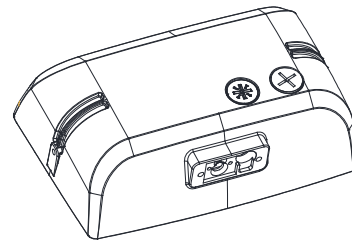

figure 6.3

Optical Angle adjustment (suitable for 150W & 300W)

Step 1: Take the lamp out of the packing box, take out the handle configured in the packing box, and insert it into the slot of the knob. (figure 6.4)

Step 2: Adjust the handle to the desired Angle by turning it left and right, as shown in the picture. (figure 6.5)

*Pictures and diagrams in this IM are for illustrative purpose only.

INSTALLATION GUIDE FOR FLEXI FLOOD LIGHT

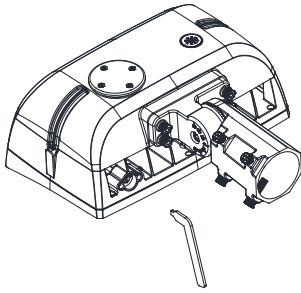

figure 6.4

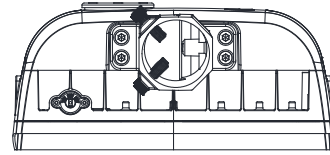

figure 6.5

Optical Angle adjustment(suitable for 150W & 300W)

- Step 1: Open the metal plug and plastic plug counterclockwise with a screwdriver. (figure 6.6)
- Step 2: Then slide the switch up and down to adjust the Angle Controller. (figure 6-6)
- Step 3: After adjusting the required control function (figure 6-6), tighten the metal plug and the plastic plug clockwise. (figure 6.6)

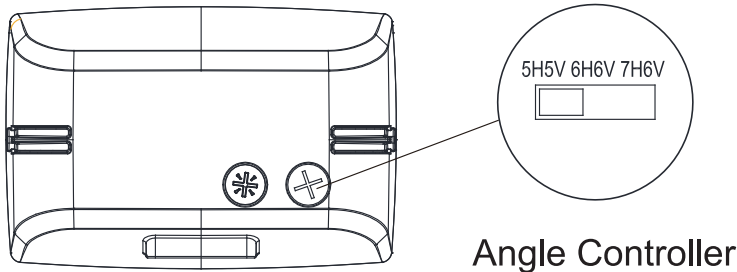

figure 6.6

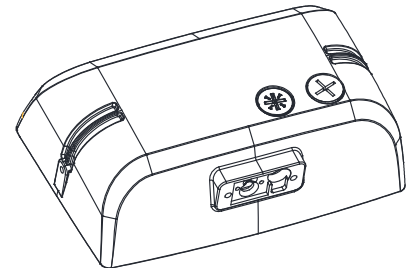

figure 6.6

*Pictures and diagrams in this IM are for illustrative purpose only.