

FLEXI

FLOOD LIGHT

Catalog#	
Project:	
Fixture Type:	Date:
Note:	

Hit the Tab key or mouse over the page to see all interactive elements.

Our Flexi Flood Light Series delivers powerful, uniform illumination designed for a wide range of outdoor and industrial applications. Built with high-efficiency and a durable die-cast aluminum housing, each model offers selectable wattage and CCT options for maximum flexibility.

FEATURES & BENEFITS

- 300W model delivers up to 45,000 lumens with high efficacy
- Fully selectable features for any environment
- Equipped with 0-10V dimming for smooth control
- Rated for 50,000 hours, offering a 5-year warranty
- Suitable for -40°C to +50°C temperatures
- Built In Photocell with ON/OFF Switch



Flexi Small: 80W



Flexi Medium: 150W



Flexi Large: 300W



BEAM SELECTABLE
7H6V/6H6V/5H5V

Model Number	Wattage	Lumens	Efficacy
HL-FL-MW-MCCT-ML3-80W	45W/60W/80W	12,000lm	150 lm/W
HL-FL-MW-MCCT-ML3-150W	100W/120W/150W	22,500lm	150 lm/W
HL-FL-MW-MCCT-ML3-300W	200W/240W/300W	45,000lm	150 lm/W
HL-FL-MW-MCCT-ML3-150W-HV**	100W/120W/150W	22,500lm	150 lm/W
HL-FL-MW-MCCT-ML3-300W-HV	200W/240W/300W	45,000lm	150 lm/W

All models feature selectable CCT options: 3000K/4000K/5000K

** Marked is Make to Order

PRODUCT SUMMARY

Efficacy 150 lm/W	Beam Angle (Selectable) 7H6V/6H6V/5H5V	THD ≤20%	Operating Temp. -40°C to +50°C	Mounting Knuckle / C Bracket / Slipfitter
CCT (Selectable) 3000/4000/5000K	Input Voltage 120-277 Vac 277-480 Vac	Surge Protection L-N:6kV,L&N-E:6kV	Warranty 5 Years	Housing Material Aluminum
CRI >80	Power Factor (PF) ≥0.9	Dimming 0-10V standard	Finish Bronze	Lens Type Glass

APPLICATIONS

- General Lighting, Building Up Lighters, Tree Lighting, Sign Lighting and Security Lighting.

STANDARD PRODUCT ACCESSORIES INCLUDED

- HL-FL-MW-MCCT-ML3-80W:** 1/2" Knuckle Mount & C-Shape Mount
- HL-FL-MW-MCCT-ML3-150W/150W-HV:** Slip Fitter Mount & C-Shape Mount
- HL-FL-MW-MCCT-ML3-300W/300W-HV:** Slip Fitter Mount & Trunnion Mount

Default Parameters	
Wattage	CCT
80W	5000K
150W	5000K
300W	5000K
150W	5000K
300W	5000K

DLC PRODUCT INFORMATION			
Order ID	DLC Model Number	DLC Source Identifier	Classification
HL-FL-MW-MCCT-ML3-80W	HL-FL-MW-MCCT-ML3-80W-AA-BB-ZZZZ	S-JHXXMJ	Premium
HL-FL-MW-MCCT-ML3-150W	HL-FL-MW-MCCT-ML3-150W-AA-BB-ZZZZ	S-ZJ8V9C	Premium
HL-FL-MW-MCCT-ML3-300W	HL-FL-MW-MCCT-ML3-300W-AA-BB-ZZZZ	S-5XWV3	Premium
HL-FL-MW-MCCT-ML3-150W-HV**	-	In Progress	Premium
HL-FL-MW-MCCT-ML3-300W-HV	HL-FL-MW-MCCT-ML3-300W-HV-AA-BB-ZZZZ	S-DBCW9	Premium

PERFORMANCE

Model Number	Wattages	Input Voltage	Distribution	3000K (>80 CRI)		4000K (>80 CRI)		5000K (>80 CRI)	
				Lumens	Efficacy	Lumens	Efficacy	Lumens	Efficacy
HL-FL-MW-MCCT-ML3-80W	45W/60W/80W	120-277 Vac	7H6V	10,400lm	130 lm/W	12,000lm	150 lm/W	11,200lm	140 lm/W
			6H6V	10,400lm	130 lm/W	12,000lm	150 lm/W	11,200lm	140 lm/W
			5H5V	10,400lm	130 lm/W	12,000lm	150 lm/W	11,200lm	140 lm/W
HL-FL-MW-MCCT-ML3-150W	100W/120W/150W	120-277 Vac	7H6V	19,500lm	130 lm/W	22,500lm	150 lm/W	21,000lm	140 lm/W
			6H6V	19,500lm	130 lm/W	22,500lm	150 lm/W	21,000lm	140 lm/W
			5H5V	19,500lm	130 lm/W	22,500lm	150 lm/W	21,000lm	140 lm/W
HL-FL-MW-MCCT-ML3-300W	200W/240W/300W	120-277 Vac	7H6V	39,000lm	130 lm/W	45,000lm	150 lm/W	42,000lm	140 lm/W
			6H6V	39,000lm	130 lm/W	45,000lm	150 lm/W	42,000lm	140 lm/W
			5H5V	39,000lm	130 lm/W	45,000lm	150 lm/W	42,000lm	140 lm/W
HL-FL-MW-MCCT-ML3-150W-HV**	100W/120W/150W	277-480 Vac	7H6V	19,500lm	130 lm/W	22,500lm	150 lm/W	21,000lm	140 lm/W
			6H6V	19,500lm	130 lm/W	22,500lm	150 lm/W	21,000lm	140 lm/W
			5H5V	19,500lm	130 lm/W	22,500lm	150 lm/W	21,000lm	140 lm/W
HL-FL-MW-MCCT-ML3-300W-HV	200W/240W/300W	277-480 Vac	7H6V	39,000lm	130 lm/W	45,000lm	150 lm/W	42,000lm	140 lm/W
			6H6V	39,000lm	130 lm/W	45,000lm	150 lm/W	42,000lm	140 lm/W
			5H5V	39,000lm	130 lm/W	45,000lm	150 lm/W	42,000lm	140 lm/W

Remarks: Lumen and efficacy data are based on the CCT of each higher wattage SKU

**Marked is Make to Order

EFFECTIVE PROJECTED AREA (EPA)

Model Number	Mounting Type	EPA Minimum	EPA Maximum
HL-FL-MW-MCCT-ML3-80W	1/2" Knuckle Mount	0.17 ft ²	0.72 ft ²
HL-FL-MW-MCCT-ML3-80W	C Clamp	0.16 ft ²	0.71 ft ²
HL-FL-MW-MCCT-ML3-150W	Slip fitter	0.43 ft ²	1.05 ft ²
HL-FL-MW-MCCT-ML3-150W	C Clamp	0.31 ft ²	0.93 ft ²
HL-FL-MW-MCCT-ML3-300W	Slip fitter	0.64 ft ²	1.58 ft ²
HL-FL-MW-MCCT-ML3-300W	Trunnion Mount	0.57 ft ²	1.43 ft ²
HL-FL-MW-MCCT-ML3-150W-HV**	Slip fitter	0.43 ft ²	1.05 ft ²
HL-FL-MW-MCCT-ML3-150W-HV**	C Clamp	0.31 ft ²	0.93 ft ²
HL-FL-MW-MCCT-ML3-300W-HV	Slip fitter	0.64 ft ²	1.58 ft ²
HL-FL-MW-MCCT-ML3-300W-HV	Trunnion Mount	0.57 ft ²	1.43 ft ²

**Marked is Make to Order

PACKAGING DETAILS

Model No.	Product Dimension (LxWxH) (in)	Case Qty (units)	Case Dimension (LxWxH) (in)	Net Weight Product (lbs)	Gross Weight with Packaging (lbs)	Pallet Load
HL-FL-MW-MCCT-ML3-80W	10.90x7.80x3.62	6	26.18x12.91x13.39	5.29	37.78	180
HL-FL-MW-MCCT-ML3-150W	13.62x9.36x5.57	1	15.04x13.98x8.58	11.15	13.37	72
HL-FL-MW-MCCT-ML3-300W	17.66x12.18x6.74	1	19.02x16.354x9.84	18.51	21.6	40
HL-FL-MW-MCCT-ML3-150W-HV**	13.62x9.36x5.57	1	15.04x13.98x8.58	11.15	13.37	72
HL-FL-MW-MCCT-ML3-300W-HV	17.66x12.18x6.74	1	19.02x16.354x9.84	18.51	21.6	40

MOUNTING DETAILS



**1/2" Knuckle Mount
(80W)**



**Slip Fitter Mount
(150W & 300W)**

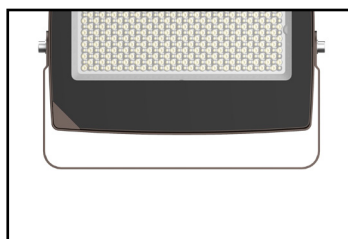

**C-Shape Mount
(80W & 150W)**



**Trunnion Mount
(300W)**

All mounting brackets are included as standard accessories (not sold separately).

CUSTOMIZATION

- Available in Bronze, or Custom Finish
- Beam Selectable option 7H6V / 6H6V / 5H5V

DIMENSIONS

SELECTABLE WATTAGE & CCT: 80W

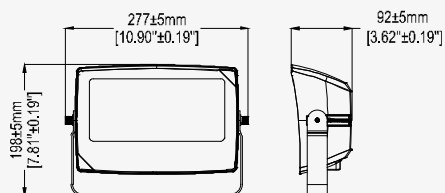

Length (L)

10.72 Inch

Width (W)

7.80 Inch

Height (H)

3.62 Inch

SELECTABLE WATTAGE & CCT: 150W/150W-HV

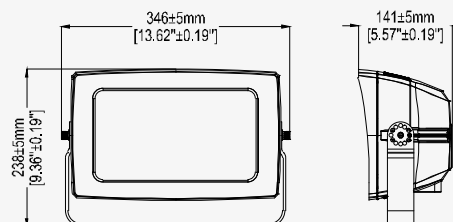

Length (L)

13.62 Inch

Width (W)

9.36 Inch

Height (H)

5.57 Inch

SELECTABLE WATTAGE & CCT: 300W/300W-HV

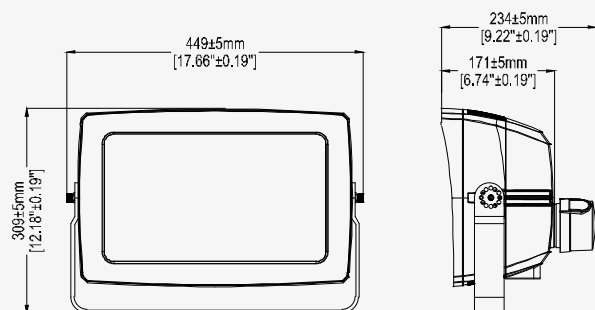

Length (L)

17.66 Inch

Width (W)

12.18 Inch

Height (H)

6.74 Inch

PHOTOMETRIC RESULT

7H6V(80W-3000K)

Luminous Intensity Distribution Curve

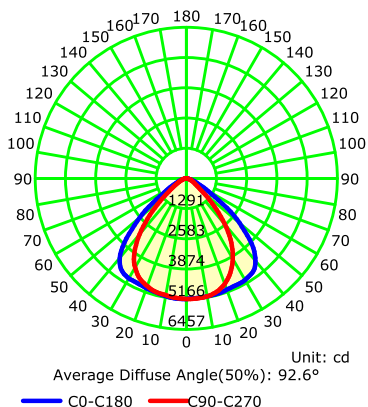

6H6V(80W-3000K)

Luminous Intensity Distribution Curve

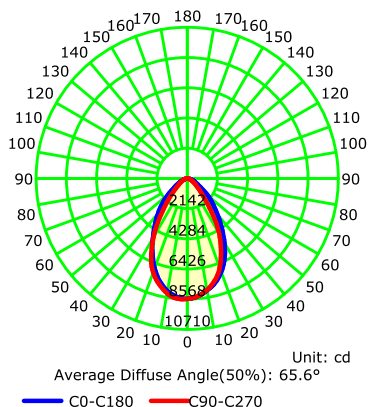

5H5V(80W-3000K)

Luminous Intensity Distribution Curve

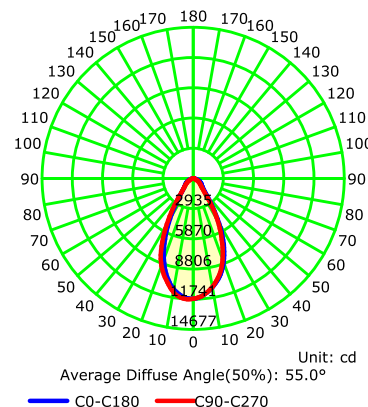

7H6V(150W-3000K)

Luminous Intensity Distribution Curve

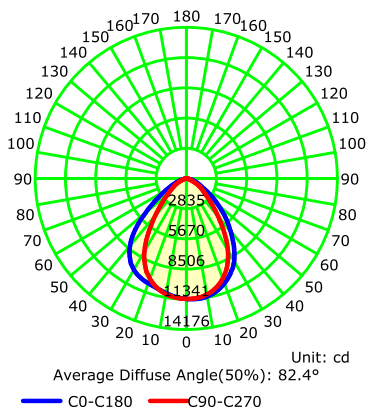

6H6V(150W-3000K)

Luminous Intensity Distribution Curve

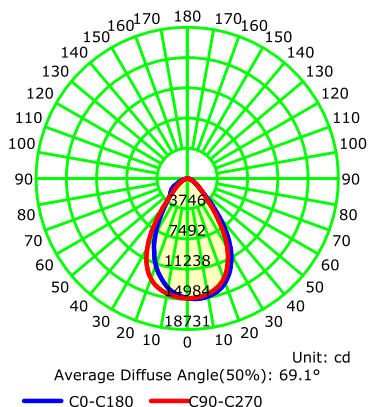

5H5V(150W-3000K)

Luminous Intensity Distribution Curve

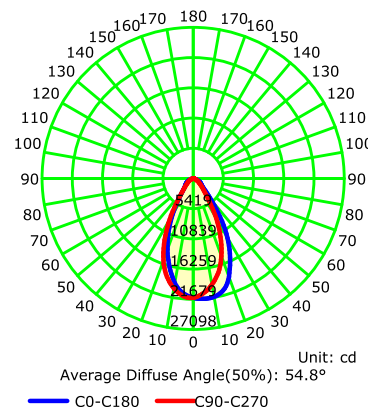

7H6V(300W-3000K)

Luminous Intensity Distribution Curve

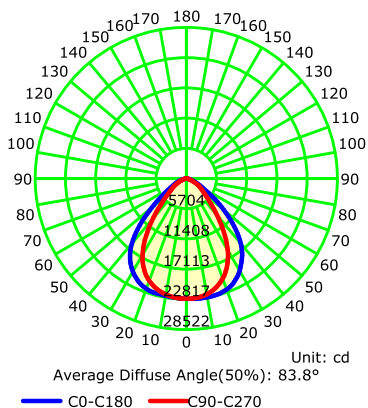

6H6V(300W-3000K)

Luminous Intensity Distribution Curve

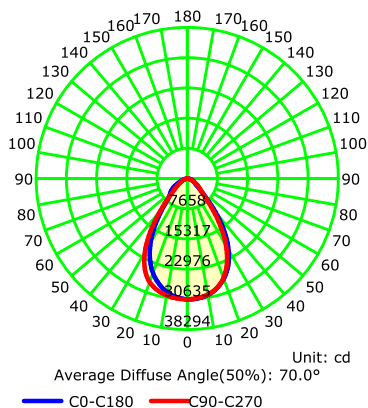

5H5V(300W-3000K)

Luminous Intensity Distribution Curve

