



SINCE 1958

A *Lighting* Factory

LAMPS TO POLE - COMPLETE LIGHTING UNDER ONE BRAND

LIGHTING
PRODUCT
CATALOG
2026
Vol. 2





Lighting Solutions for Distributors

At Havells Lighting, we believe in building partnerships that go beyond business. Our distributor network forms the foundation of our growth, ensuring that high-performance lighting solutions reach every corner of the market. With a commitment to quality, reliability, and innovation, we empower our distributors with the tools, support, and products they need to serve their customers with confidence.



QUICK SHIP PROGRAM

We understand nothing is more precious than time. This is where our same-day shipping program helps you meet tight deadlines without worrying about the quality of our lighting solutions. Taking on more projects will never be easier!



CUSTOMIZED SOLUTIONS

Our team works closely with you to deliver tailored lighting solutions that align with your project requirements and market needs. From product specifications to technical support, we ensure you have the flexibility and expertise to meet every demand with confidence.



EXTENSIVE PRODUCT RANGE

Gain access to one of the most comprehensive lighting portfolios in the industry. Our seven decades of experience in the FMCG industry provides a diverse range of lighting solutions, from simple lamps to powerful sign lighting.



| About Us

Havells Lighting stands as a well-established and trusted lighting company across the United States. Our US headquarters is located in Anderson, South Carolina, where dedicated teams support distributors and partners with speed, clarity and consistency. Global operations are based at QRG Towers in Noida, India where engineering, product development and strategic planning take shape. This strong global and local presence helps Havells remain closely aligned with market needs while delivering dependable lighting solutions for commercial and industrial environments.

With over 70 years of industry experience, Havells designs lighting solutions that consistently deliver value and performance. Our product portfolio includes flat panels, troffers, downlights, round high bays, linear high bays, strip lights, wall packs, area lights, floodlights, reducers, bullhorns, adapters, poles and sign lamps and accessories. Every solution reflects a focus on quality, safety, ease of installation and compliance, enabling distributors to serve a wide range of applications with confidence.

Havells focuses on building sustainable lighting solutions designed to perform reliably over the long term. By combining innovation with responsible manufacturing, we help partners meet modern lighting requirements without compromise. This commitment allows us to support distributors with products that align with evolving standards while delivering consistent outcomes across every illuminated space.

| Core Values

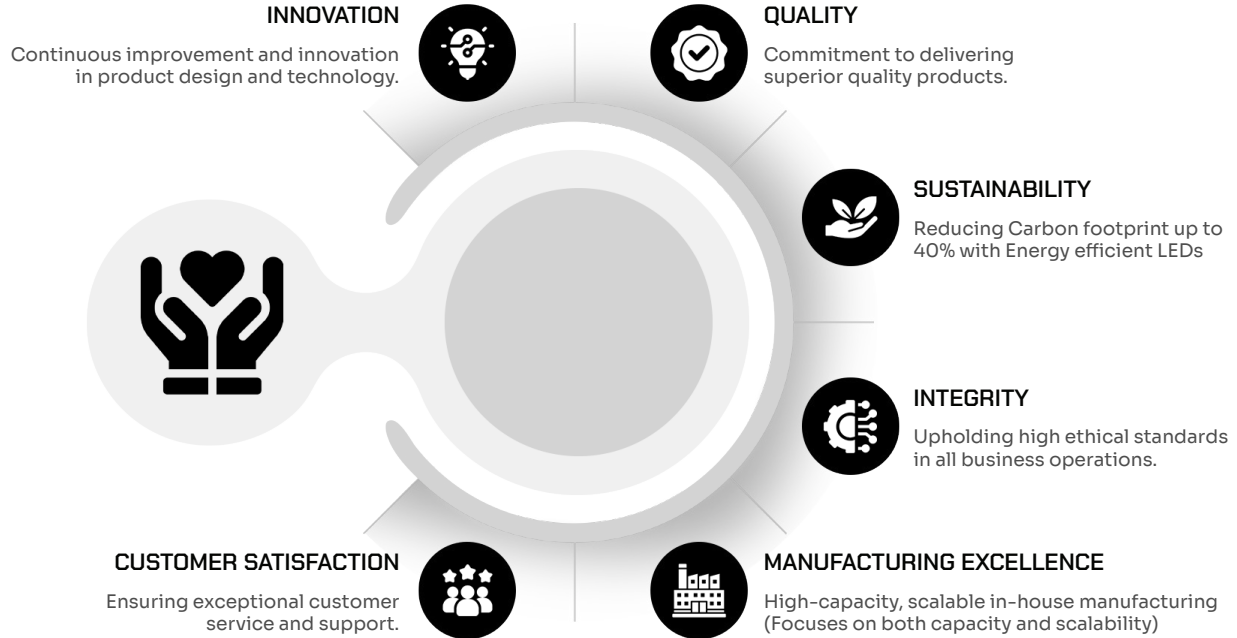



GONIO PHOTOMETER

Our in-house goniometer photometer measures the complete light distribution of every luminaire, generating precise photometric data that supports accurate lighting distribution.



INTEGRATING SPHERE

Our integrating sphere system measures total lumen output and color performance of light sources, ensuring consistent efficiency and color stability.



UL CERTIFIED LAB

An in-house UL lab for testing that meets all the rigorous safety standards & regulations.



DRIVER MANUFACTURING

Vertically integrated LED driver production leads to greater longevity in our lighting solutions, making them more reliable.





HAVELLS

**EXPERIENCE INNOVATION IN EVERY GLOW
THAT REDEFINES DESIGN AND COMFORT**



| INDOOR LIGHTING

Hercules Gen 2 Panel Light.....	8
Troffer Center Basket.....	10
Rapid Retro Panel Door.....	12
Rapid Retro Troffer Door.....	14
External Driver Downlight.....	16
Retrofit Downlight.....	18
Retrofit Downlight Gen 2.....	20
Disk Light.....	22
Puff Light.....	24
Titania Plus T8 LED Tube.....	26
Titania Select Hybrid T8 LED Tube.....	28
Titania Select Retrofit Emergency T8 LED Tube.....	29
Titania Pro LED Batten.....	30
Led Linear Suspended Up & Down Light.....	32
Adore A19 Lamp.....	34
Edge-lit LED Mirror.....	36
LED Cooler Light.....	38

HERCULES GEN 2 PANEL LIGHT

Havells Hercules Panel Light is a recessed backlit fixture available in three sizes with selectable wattage and CCT options via a switch. It combines modern aesthetics with easy installation and delivers high output of up to 6,000 lumens at 50W.

Equipped with Integral NEC compliant Earthquake Clips

Sturdy Back Plate housing ensures durability



Side Mounted Driver housing

We deliver up to 50W, while others offer up to only 40W



FEATURES

- Selectable CCT & wattage for maximum optimization
- Available in three variant sizes -2x2, 2x4 & 1x4
- Motion sensor or emergency driver offered as optional add-ons
- Offers up to 6,000lm in the 2x4 model for superior brightness

SIZE	DIMENSIONS(LXWXH)
2x2	23.7" x 23.7" x 1.4"
2x4	47.7" x 23.7" x 1.4"
1x4	47.7" x 11.8" x 1.4"

- Up to 6,000lm**
Lumens (lm)
- 20W-50W**
Wattages (W)
- 0-10V**
Dimming Capabilities
- IP20**
Suitable for Dry/Damp Location
- 50,000 hours**
Rated Life
- 5 Year**
Product Warranty

PRODUCT NUMBER	SELECTABLE WATTAGE (W)	SYSTEM LUMENS (LM)	LUMENS EFFICACY (LM/W)	SELECTABLE CCT (K)
HL-2x2-MW-MCCT-BACK-LIT PANEL	20W/30W/40W	4,800lm	120 lm/W	3500K/4000K/5000K
HL-2x4-MW-MCCT-BACK-LIT PANEL	30W/40W/50W	6,000lm	120 lm/W	3500K/4000K/5000K
HL-1x4-MW-MCCT-BACK-LIT PANEL	20W/30W/40W	4,800lm	120 lm/W	3500K/4000K/5000K
★ HL-2x4-4MW-5MCCT-BACK-LIT PANEL	25W/34W/42W/50W	6,000lm	120 lm/W	3000K/3500K/4000K/5000K/6500K
HL-2x2-MW-MCCT-BACK-LIT PANEL-EM	20W/30W/40W	4,800lm	120 lm/W	3500K/4000K/5000K
HL-2x4-MW-MCCT-BACK-LIT PANEL-EM	30W/40W/50W	6,000lm	120 lm/W	3500K/4000K/5000K
HL-1x4-MW-MCCT-BACK-LIT PANEL-EM**	20W/30W/40W	4,800lm	120 lm/W	3500K/4000K/5000K
HL-2x2-MW-MCCT-BACK-LIT PANEL-MS	20W/30W/40W	4,800lm	120 lm/W	3500K/4000K/5000K
HL-2x4-MW-MCCT-BACK-LIT PANEL-MS	30W/40W/50W	6,000lm	120 lm/W	3500K/4000K/5000K
HL-1x4-MW-MCCT-BACK-LIT PANEL-MS**	20W/30W/40W	4,800lm	120 lm/W	3500K/4000K/5000K

Additional Accessories: 10W Remote Emergency Battery Backup (HL-EM-01-01-1), Motion Sensor (HL-ANT-1P-4T) and RC-100 Sensor Remote Control (Remote-HL-ANT-1P-4T).

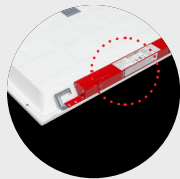

Panel light with factory-fitted emergency battery backup (in EM code only).

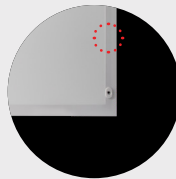

Panel light with motion sensor base. (in MS code only).

(** marked is Make to Order)

(★ marked is available from Quarter 3)

*(Declared Lumens at 3500K at Highest Wattage)

A versatile lighting solution with fully selectable CCT and wattage, designed to deliver optimized performance across commercial spaces. Available in 2x2 and 2x4 sizes, it offers high brightness output with an optional motion sensor.



FEATURES

- Selectable CCT & wattage for maximum optimization
- Available in two variant sizes -2x2, 2x4
- Motion sensor offered as optional add-ons
- Offers up to 6,500 lumens in the 2x4 model for high brightness

SIZE	DIMENSIONS(LXWXH)
2x2	23.74" × 23.74" × 2.08"
2x4	47.75" × 23.74" × 2.08"

PRODUCT NUMBER	SELECTABLE WATTAGE [W]	SYSTEM LUMENS [LM]	LUMENS EFFICACY [LM/W]	SELECTABLE CCT [K]	INPUT VOLTAGE [V]
HL-TR-2X2-MW-MCCT-TROFFER	20W/30W/40W	5,200lm	130 lm/W	3500K/4000K/5000K	120-277 Vac
HL-TR-2X4-MW-MCCT-TROFFER	30W/40W/50W	6,500lm	130 lm/W	3500K/4000K/5000K	120-277 Vac
HL-TR-2X2-MW-MCCT-TROFFER-EM	20W/30W/40W	5,200lm	130 lm/W	3500K/4000K/5000K	120-277 Vac
HL-TR-2X4-MW-MCCT-TROFFER-EM	30W/40W/50W	6,500lm	130 lm/W	3500K/4000K/5000K	120-277 Vac
HL-TR-2X2-MW-MCCT-TROFFER-MS	20W/30W/40W	5,200lm	130 lm/W	3500K/4000K/5000K	120-277 Vac
HL-TR-2X4-MW-MCCT-TROFFER-MS	30W/40W/50W	6,500lm	130 lm/W	3500K/4000K/5000K	120-277 Vac

Additional Accessories: Motion Sensor (HL-ANT-1P-4T).

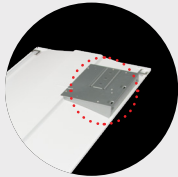

Troffer with factory-fitted emergency battery backup (in EM code only).

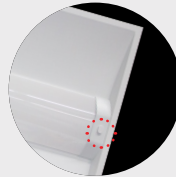

Troffer with motion sensor base. (in MS code only).

*(Declared Lumens at 4000K at Highest Wattage)

RAPID RETRO PANEL DOOR

Our Rapid Retro Panel Door is an eco-friendly, patented luminaire designed with a sleek, modern recess-mounting system. It features selectable CCT, wattage, and dimming options, allowing users to customize their lighting experience.

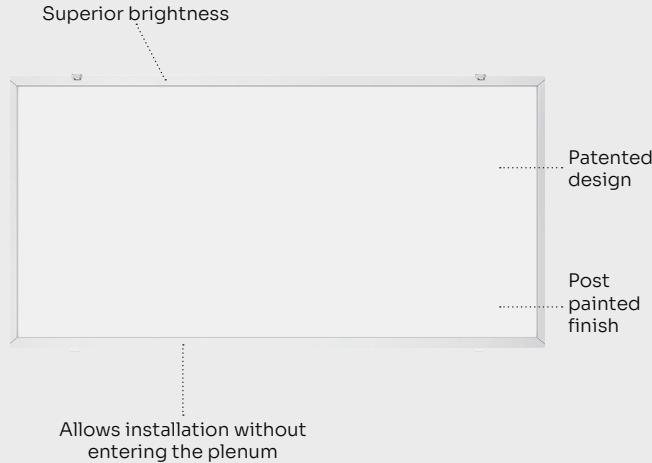

FEATURES

- Offers up to 6,092lm in the 2x4 model for superior brightness
- Adjustable CCT and wattage allow precise lighting control
- Equipped with 0-10V dimming for smooth control
- 50,000-hour rated life with 5-year warranty
- Surface mounting option available

SIZE	DIMENSIONS(LXWXH)
2x4	46.65" x 23.22" x 3.0"
1x4	47.96" x 12.56" x 2.1"
2x2	23.90" x 23.90" x 2.1"

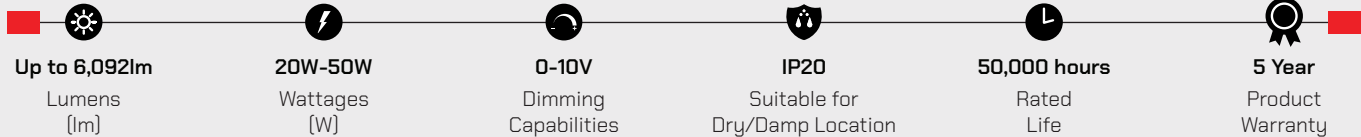

Up to 6,092lm
Lumens (lm)

20W-50W
Wattages (W)

0-10V
Dimming Capabilities

IP20
Suitable for Dry/Damp Location

50,000 hours
Rated Life

5 Year
Product Warranty

PRODUCT SPECIFICATIONS

PRODUCT NUMBER	SELECTABLE WATTAGE [W]	SYSTEM LUMENS [LM]	LUMENS EFFICACY [LM/W]	SELECTABLE CCT [K]	INPUT VOLTAGE [V]
HL-2X4-MW-MCCT-50W-Retro Panel	30W/40W/50W	6,092lm	134 lm/W	3500K/4000K/5000K	120-277 Vac
HL-1X4-MW-MCCT-36W-Retro Panel	16W/26W/36W	4,604lm	137 lm/W	3500K/4000K/5000K	120-277 Vac
HL-2X2-MW-MCCT-36W-Retro Panel	16W/26W/36W	4,572lm	133 lm/W	3500K/4000K/5000K	120-277 Vac

Additional Accessories: Remote Emergency Battery Backup (HL-EM-02-01-1), 2x4 Surface Mount Kit (HL-RRP-Retro Panel - 2X4 Surface Kit), 1x4 Surface Mount Kit (HL-RRP-Retro Panel - 1X4 Surface Kit), and 2x2 Surface Mount Kit (HL-RRP-Retro Panel - 2x2 Surface Kit).

*(Declared Lumens at 4000K at Highest Wattage)

RAPID RETRO TROFFER DOOR

A retrofit-ready troffer solution featuring fully selectable options and smooth 0-10V dimming for adaptable lighting control. Available in 2x2 and 2x4 sizes, it delivers long-lasting performance with a 50,000 hour lifespan and 5 year warranty.

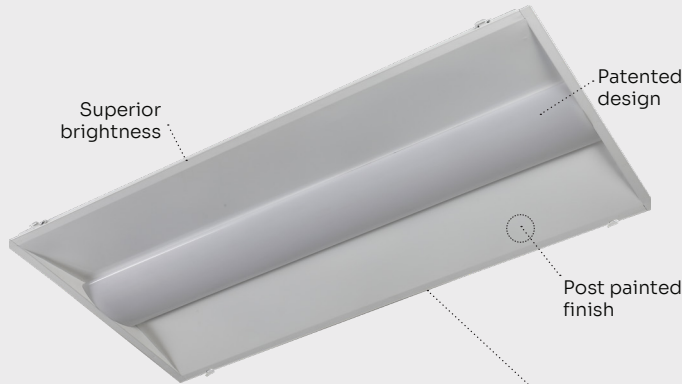

Superior
brightness

Patented
design

Post painted
finish

Allows installation without
entering the plenum



FEATURES

- Selectable CCT & wattage for maximum optimization
- Available in two variant sizes -2x2, 2x4
- Equipped with 0-10V dimming for smooth control.
- 50,000-hour rated life with 5-year warranty.

SIZE	DIMENSIONS(LXWXH)
2x2	23.74" x 23.74" x 1.48"
2x4	46.62" x 22.80" x 2.29"

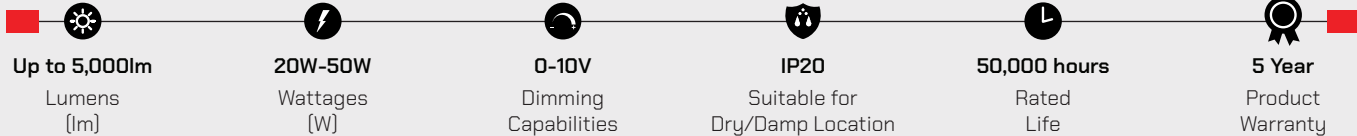

- Up to 5,000lm**
Lumens (lm)
- 20W-50W**
Wattages (W)
- 0-10V**
Dimming Capabilities
- IP20**
Suitable for Dry/Damp Location
- 50,000 hours**
Rated Life
- 5 Year**
Product Warranty

PRODUCT SPECIFICATIONS

PRODUCT NUMBER	SELECTABLE WATTAGE [W]	SYSTEM LUMENS [LM]	LUMENS EFFICACY [LM/W]	SELECTABLE CCT [K]	INPUT VOLTAGE [V]
HL-2X2-MW-MCCT-40W-Retro Troffer**	20W/30W/40W	5182lm	125 lm/W	3500K/4000K/5000K	120-277 Vac
HL-2X4-MW-MCCT-50W-Retro Troffer	30W/40W/50W	5182lm	125 lm/W	3500K/4000K/5000K	120-277 Vac

Additional Accessories: Remote Emergency Battery Backup (HL-EM-02-01-1) and Surface Mount Kit (HL-RRP-Retro Troffer - Surface Kit).

(** marked is Make to Order)

*(Declared Lumens at 4000K at Highest Wattage)

EXTERNAL DRIVER

DOWNLIGHT

The External Driver Flat Disk is a versatile, low-profile LED round downlight ideal for new construction and drywall ceilings. It clips directly into the ceiling without the need for a housing or a ceiling can.

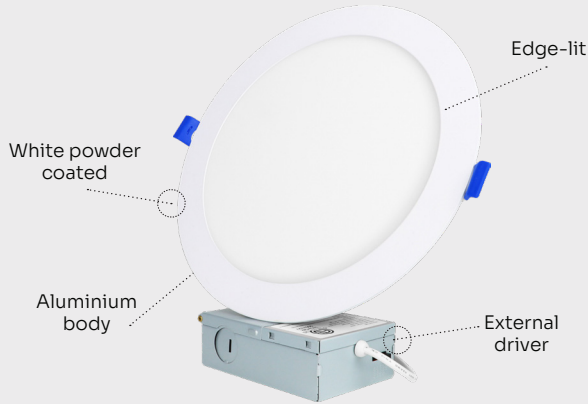







FEATURES

- High efficacy with 8" light delivers 1,480 lumens
- Selectable CCT for optimal customization
- Operating temperature: -20°C to +45°C
- Rated life of 50,000 hours, offering a 5-year warranty

SIZE	DIMENSIONS(DXH)
3IN	3.50" x 0.59"
4IN	4.73" x 0.59"

SIZE	DIMENSIONS(DXH)
6IN	6.69" x 0.59"
8IN	8.66" x 0.59"

						
Up to 1,480lm	6W-18W	Wet	90	Triac	50,000 hours	5 Year
Lumens (lm)	Wattages (W)	Location Proof	Color Rendering Index (CRI)	Dimming Capabilities	Rated Life	Product Warranty

PRODUCT SPECIFICATIONS

PRODUCT NUMBER	PRODUCT WATTAGES [W]	SYSTEM LUMENS [LM]	LUMENS EFFICACY [LM/W]	SELECTABLE CCT [K]	INPUT VOLTAGE [V]
HL-DLE-6W-MCCT-3 Inch	6W	492lm	82 lm/W	2700K/3000K/3500K/4000K/5000K	120 Vac
HL-DLE-9W-MCCT-4 Inch	9W	738lm	82 lm/W	2700K/3000K/3500K/4000K/5000K	120 Vac
HL-DLE-12W-MCCT-6 Inch	12W	985lm	82 lm/W	2700K/3000K/3500K/4000K/5000K	120 Vac
HL-DLE-18W-MCCT-8 Inch	18W	1,480lm	82 lm/W	2700K/3000K/3500K/4000K/5000K	120 Vac

Additional Accessories: 3-pin Extension Cord (10") (HL-DLE-Extension Cord-10"), 3-pin Extension Cord (20") (HL-DLE-Extension Cord-20"), Remote Emergency Battery Backup (HL-DLE-MCCT-EM) and Black Color Trim (HL-DLE-TRIM-Black).

*(Declared Lumens at 4000K)

At Havells Lighting, our LED Retrofit downlights are designed to seamlessly fit into existing 4” and 5”/6” downlight fixtures with aluminum powder coated housing. These downlights provide a sleek, modern upgrade to homes or businesses without the need for extensive remodeling.

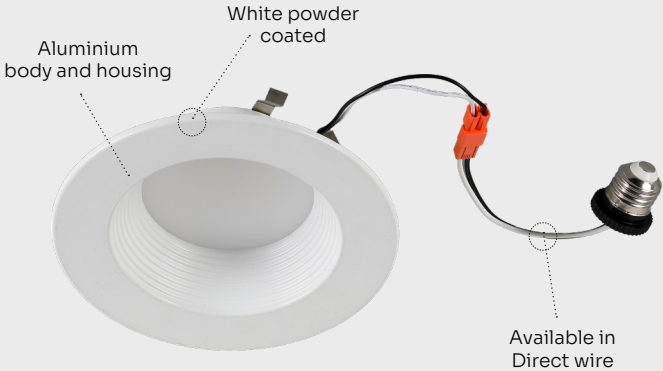

FEATURES

- High efficacy, with the 6” light delivers 1,230 lumens
- Selectable CCT for optimal customization
- Operating temperature: -20°C to +45°C
- Rated life of 50,000 hours, offering a 5-year warranty

SIZE	DIMENSIONS(DXH)
4IN	5.0” x 1.8”
6IN	7.4” x 2.5”



- Up to 1,230lm**
Lumens (lm)
- 9W | 15W**
Wattages (W)
- Wet**
Location Proof
- 80**
Color Rendering Index (CRI)
- Triac**
Dimming Capabilities
- 50,000 hours**
Rated Life
- 5 Year**
Product Warranty



PRODUCT SPECIFICATIONS

PRODUCT NUMBER	PRODUCT WATTAGE (W)	SYSTEM LUMENS (LM)	LUMENS EFFICACY (LM/W)	SELECTABLE CCT (K)	INPUT VOLTAGE (V)
HL-DLR-9W-MCCT-4 Inch	9W	738lm	82 lm/W	2700K/3000K/3500K/4000K/5000K	120 Vac
HL-DLR-15W-MCCT-6 Inch	15W	1,230lm	82 lm/W	2700K/3000K/3500K/4000K/5000K	120 Vac

*(Declared Lumens at 4000K at Highest Wattage)



RETROFIT

DOWNLIGHT GEN 2



At Havells Lighting, our LED Retrofit downlight Gen 2 is designed to seamlessly fit into existing 4" and 5"/6" downlight fixtures with aluminum powder coated housing. These downlights provide a sleek, modern upgrade to homes or businesses without the need for extensive remodeling.



FEATURES

- High efficacy, with the 6" light delivers 1,230 lumens
- Selectable CCT & wattage for maximum optimization
- Operating temperature: -20°C to +45°C
- Rated life of 50,000 hours, offering a 5-year warranty

SIZE	DIMENSIONS(DXH)
4IN	5.0" x 1.9"
6IN	7.4" x 2.2"

Up to 1,230lm	5W-15W	Wet	90	Triac	50,000 hours	5 Year
Lumens (lm)	Wattages (W)	Location Proof	Color Rendering Index (CRI)	Dimming Capabilities	Rated Life	Product Warranty



PRODUCT SPECIFICATIONS

PRODUCT NUMBER	SELECTABLE WATTAGE [W]	SYSTEM LUMENS [LM]	LUMENS EFFICACY [LM/W]	SELECTABLE CCT [K]	INPUT VOLTAGE [V]
HL-DLR-MW-MCCT-9W-4 Inch	5W/7W/9W	738lm	82 lm/W	2700K/3000K/3500K/4000K/5000K	120 Vac
HL-DLR-MW-MCCT-15W-6 Inch	9W/12W/15W	1,230lm	82 lm/W	2700K/3000K/3500K/4000K/5000K	120 Vac

*(Declared Lumens at 4000K at Highest Wattage)

DISK LIGHT

The Havells Lighting Disk Light is designed to seamlessly fit into existing 4” and 6” downlight fixtures with aluminum powder coated housing. These disk lights provide a sleek, modern upgrade to homes or businesses without the need for extensive remodeling.

Wattage and CCT selection switch



Flush mount against ceiling

Backlit



FEATURES

- High efficacy, with the 6” light delivers 1,230 lumens
- Selectable CCT & wattage for maximum optimization
- Operating temperature: -20°C to +45°C
- Rated life of 50,000 hours, offering a 5-year warranty

SIZE	DIMENSIONS(DXH)
4IN	6.0” x 1.0”
6IN	7.4” x 1.0”

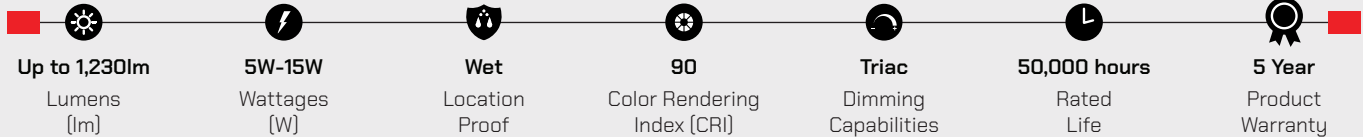

- Up to 1,230lm**
Lumens (lm)
- 5W-15W**
Wattages (W)
- Wet**
Location Proof
- 90**
Color Rendering Index (CRI)
- Triac**
Dimming Capabilities
- 50,000 hours**
Rated Life
- 5 Year**
Product Warranty

PRODUCT SPECIFICATIONS

PRODUCT NUMBER	SELECTABLE WATTAGES [W]	SYSTEM LUMENS [LM]	LUMENS EFFICACY [LM/W]	SELECTABLE CCT [K]	INPUT VOLTAGE [V]
HL-DLS-MW-MCCT-9W-4 Inch	5W/7W/9W	738lm	82 lm/W	2700K/3000K/3500K/4000K/5000K	120 Vac
HL-DLS-MW-MCCT-15W-6 Inch	9W/12W/15W	1,230lm	82 lm/W	2700K/3000K/3500K/4000K/5000K	120 Vac

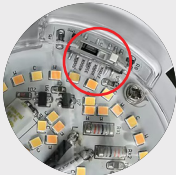

CCT can be adjusted from below the removable diffuser.



Wattage can be adjusted from below the removable diffuser.

*(Declared Lumens at 4000K at Highest Wattage)

PUFF LIGHT

Known for their versatility, our Puff Lights or round decorative moon lights are ideal for bathrooms, guest room entries, outdoor vanity areas, and apartment ceilings. They create a pleasant ambiance while offering 50,000 hours of dependable performance.

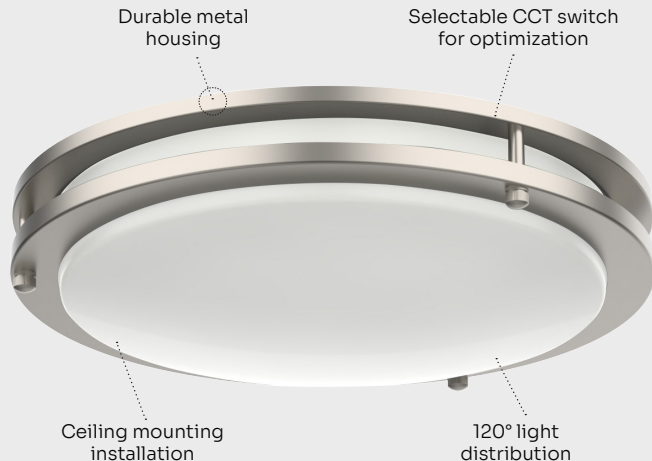

FEATURES

- Delivers up to 1,994 lumens for clear and even lighting
- Adjustable CCT allows easy customization for any mood
- Operating temperature: -20°C to +40°C
- 50,000-hour rated life with 5-year warranty.

WATTAGE	DIMENSIONS(DXH)
18W	12" x 2.55"
24W	15" x 2.75"

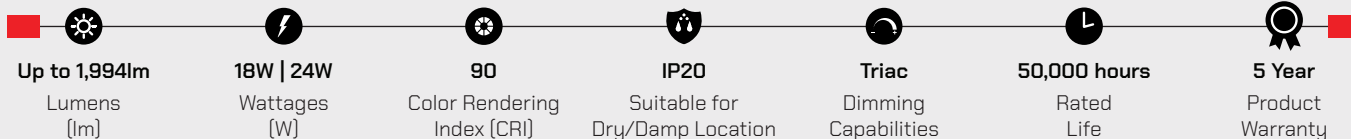

- Up to 1,994lm**
Lumens (lm)
- 18W | 24W**
Wattages (W)
- 90**
Color Rendering Index (CRI)
- IP20**
Suitable for Dry/Damp Location
- Triac**
Dimming Capabilities
- 50,000 hours**
Rated Life
- 5 Year**
Product Warranty



PRODUCT SPECIFICATIONS

PRODUCT NUMBER	PRODUCT WATTAGE (W)	SYSTEM LUMENS (LM)	LUMENS EFFICACY (LM/W)	SELECTABLE CCT (K)	INPUT VOLTAGE (V)
HL-PL-18W-MCCT-12 Inch	18W	1,541lm	84 lm/W	2700K/3000K/3500K/4000K/5000K	120 Vac
HL-PL-24W-MCCT-15 Inch	24W	1,994lm	83 lm/W	2700K/3000K/3500K/4000K/5000K	120 Vac

*(Declared Lumens at 3500K)

TITANIA PLUS T8 LED TUBE

The Titania Plus T8 LED Tubes provide powerful, reliable illumination that upgrades existing fluorescent or LED tube setups. Their direct wiring design ensures long-lasting efficiency and smooth indoor operation.

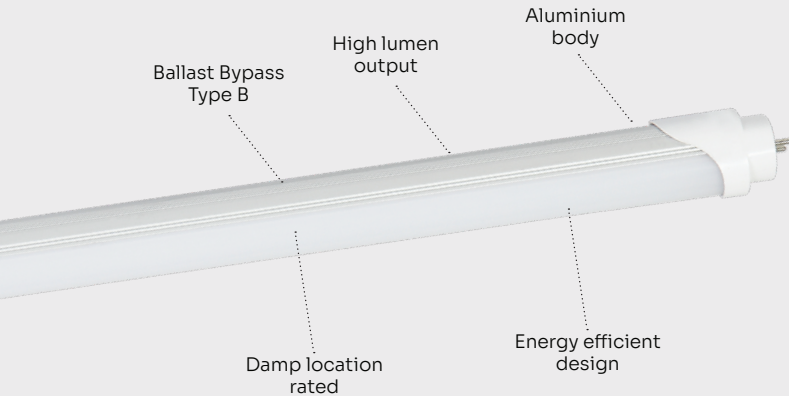

FEATURES

- Provides up to 1,600 lumens for high light output
- Reliable use in both dry and damp areas
- Operates efficiently between -10°C to +35°C
- Ballast by-pass Type -B tubes

WATTAGE	DIMENSIONS(DXL)
11W	48" x 1.3"

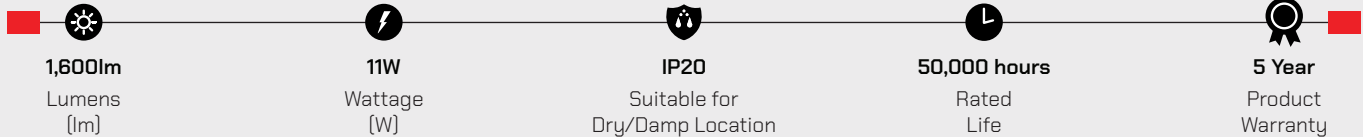



PRODUCT SPECIFICATIONS

PRODUCT NUMBER	PRODUCT WATTAGE [W]	SYSTEM LUMENS [LM]	LUMENS EFFICACY [LM/W]	PRODUCT CCT [K]	INPUT VOLTAGE [V]
HL-T8-11W4KCLR-4 Feet	11W	1,600lm	145 lm/W	4000K	100-277 Vac
HL-T8-11W5KCLR-4 Feet	11W	1,600lm	145 lm/W	5000K	100-277 Vac
HL-T8-11W4KFRO-4 Feet	11W	1,600lm	145 lm/W	4000K	100-277 Vac
HL-T8-11W5KFRO-4 Feet	11W	1,600lm	145 lm/W	5000K	100-277 Vac

TITANIA SELECT HYBRID T8 LED TUBE



Titania Select Hybrid T8 LED Tube designed for dual compatibility with ballast and direct mains operation, offering easy retrofit installation, reliable performance, and energy-efficient illumination for commercial and industrial applications.

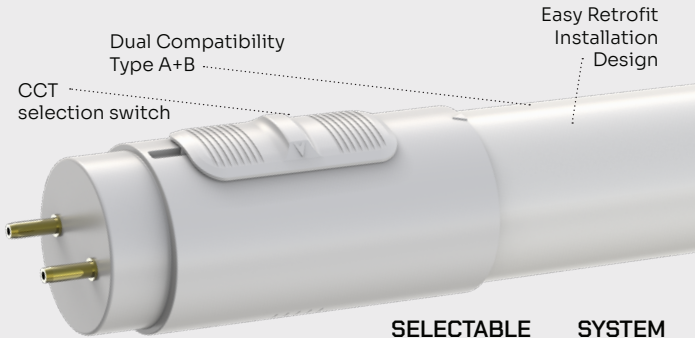







WATTAGE [SIZE]	DIMENSIONS(LXWXH)
14W (4FT)	47.17" × 1.10" × 1.10"
18W (4FT)	47.17" × 1.10" × 1.10"

FEATURES

- Selectable CCT for optimal customization
- Supports ballast and direct wiring for flexible installation
- Ideal replacement for fluorescent tubes without modification
- Operating temperature: -20°C to +45°C

PRODUCT NUMBER	SELECTABLE WATTAGE [W]	SYSTEM LUMENS [LM]	LUMENS EFFICACY [LM/W]	SELECTABLE CCT [K]	INPUT VOLTAGE [V]
HL-T8G-14W-AB-MCCT-4 Feet	14W	1,850lm	132 lm/W	3000K/3500K/4000K/5000K/6500K	120 Vac
HL-T8G-18W-AB-MCCT-4 Feet	18W	2,350lm	131 lm/W	3000K/3500K/4000K/5000K/6500K	120 Vac

					
Up to 2,350lm Lumens [lm]	14W 18W Wattage [W]	Triac Dimming Capabilities	IP20 Suitable for Dry/Damp Location	50,000 hours Rated Life	5 Year Product Warranty

TITANIA SELECT RETROFIT EMERGENCY T8 LED TUBE

Integrated emergency LED tube with inbuilt battery that activates during power failure, ensuring uninterrupted illumination. Dual-mode operation enables seamless switching with reliable, energy-efficient performance.

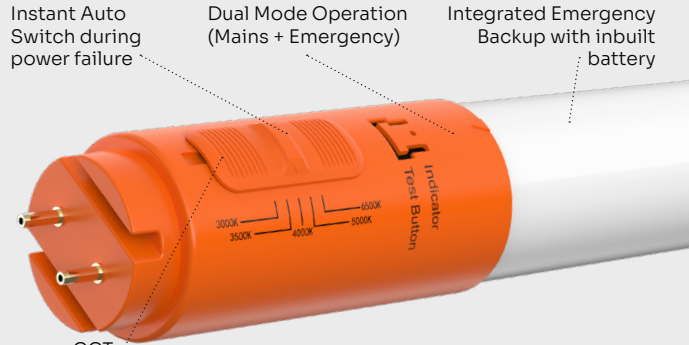







WATTAGE [SIZE]	DIMENSIONS(LXWXH)
4FT	47.17" x1.11" x 1.11"

FEATURES

- Selectable CCT for optimal customization
- Consistent illumination during power outages
- Up to 120 minutes reliable backup runtime
- Operating temperature: -25°C to +45°C

PRODUCT NUMBER	SELECTABLE WATTAGE [W]	SYSTEM LUMENS [LM]	LUMENS EFFICACY [LM/W]	SELECTABLE CCT [K]	INPUT VOLTAGE [V]
HL-T8G-12.5W-MCCT-4 Feet-EM	12.5W	1,660lm	130 lm/W	3000K/3500K/4000K/5000K/6500K	120 Vac

					
Up to 1,660lm Lumens [lm]	12.5W Wattage [W]	Triac Dimming Capabilities	IP20 Suitable for Dry/Damp Location	50,000 hours Rated Life	5 Year Product Warranty

TITANIA PRO LED BATTEN

Engineered for clarity and consistency, the Titania Pro Batten elevates any indoor environment. You can choose between 4ft or 8ft models designed for flexible installation.

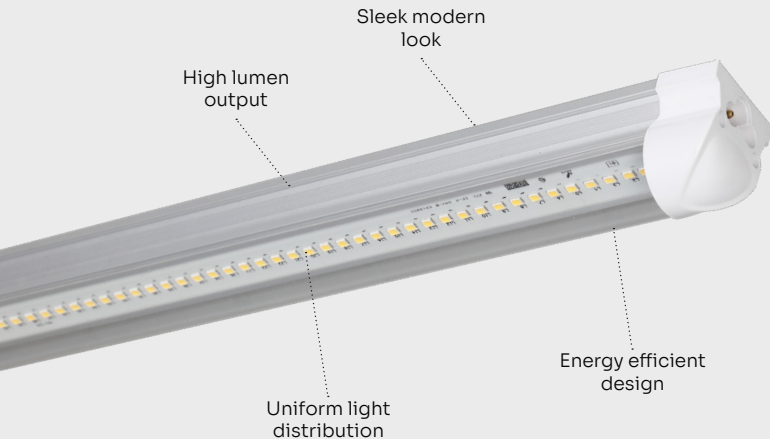

FEATURES

- Delivers high efficacy in 50W light providing up to 6,000lm
- Reliable use in both dry and damp areas
- Operating temperature: -20°C to +45°C
- Rated 50,000 hours for reliable performance

SIZE	DIMENSIONS(LXWXH)
4FT	47.24" x 1.38" x 1.21"
8FT	94.49" x 1.38" x 1.21"

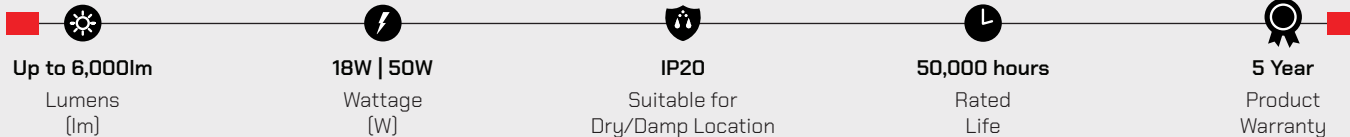



PRODUCT SPECIFICATIONS

PRODUCT NUMBER	PRODUCT WATTAGES [W]	SYSTEM LUMENS [LM]	LUMENS EFFICACY [LM/W]	PRODUCT CCT [K]	INPUT VOLTAGE [V]
HL-FB-18W57K-4 Feet	18W	2,160lm	120 lm/W	5700K	100-277 Vac
HL-FB-50W57K-8 Feet	50W	6,000lm	120 lm/W	5700K	100-277 Vac

Additional Accessories: 1 ft Power Cable (HL-FB-1FEET-PC), Mounting Clip (HL-FB-MC), 1 ft Connecting Cable (HL-FB-1FEET-CC), Butt Connector (HL-FB-BC), and End Cap (HL-FB-EC).

LED LINEAR SUSPENDED UP & DOWN LIGHT

LED linear suspended light offers flexible performance, attractive design, simple installation with suspended, wall, or ceiling mounting, four splicing methods, and includes suspended mounting accessories.

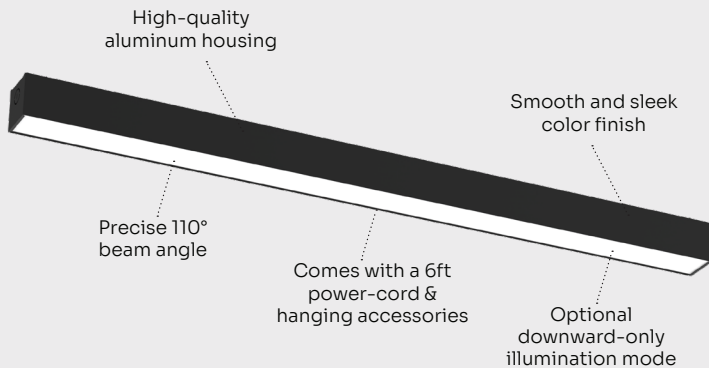

FEATURES

- Selectable CCT & wattage for maximum optimization
- Suspension kit included for easy hanging installation
- Available in black & white
- Works well from -20°C to +40°C temperatures

WATTAGE	DIMENSIONS(LXWXH)
85W	46.57" x 2.76" x 2.6"
170W	93.03" x 2.76" x 2.6"

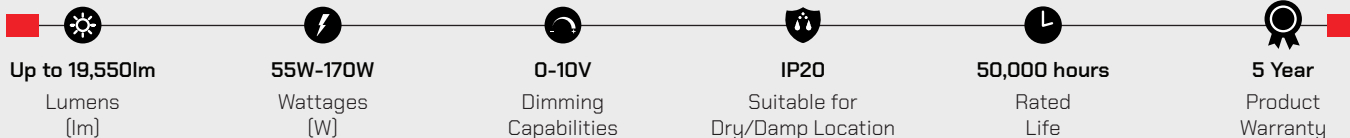

Up to 19,550lm
Lumens (lm)

55W-170W
Wattages (W)

0-10V
Dimming Capabilities

IP20
Suitable for Dry/Damp Location

50,000 hours
Rated Life

5 Year
Product Warranty

PRODUCT SPECIFICATIONS

PRODUCT NUMBER	SELECTABLE WATTAGE [W]	SYSTEM LUMENS [LM]	LUMENS EFFICACY [LM/W]	SELECTABLE CCT [K]	INPUT VOLTAGE [V]
HL-SSQ-MW-MCCT-85W-4 Feet-XX	55W/70W/85W	9,775lm	115 lm/W	3000K/4000K/5000K	120-277 Vac
HL-SSQ-MW-MCCT-170W-8 Feet-XX**	110W/140W/170W	19,550lm	115 lm/W	3000K/4000K/5000K	120-277 Vac

Additional Accessories: Wall Mounted Accessories (HL-SSI-WM), Ceiling Mounted Accessories (HL-SSI-CM), I Shape Joint Connector (HL-SSQ-I-CONNECTOR), L Shape Joint Connector (HL-SSQ-L-CONNECTOR), T Shape Joint Connector (HL-SSQ-T-CONNECTOR) and X Shape Joint Connector (HL-SSQ-X-CONNECTOR)

*XX=Black or White Color Finish.

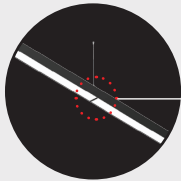

“I” type continuous run installations with a straight shape joint connector.

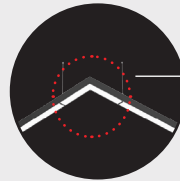

“L” type continuous run installations with a L shape joint connector.

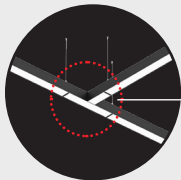

“T” type continuous run installations with a T shape joint connector.

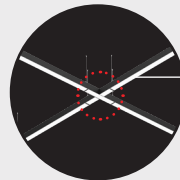

“X” type continuous run installations with a X shape joint connector.

(** marked is Make to Order)

*(Declared Lumens at 4000K at Highest Wattage)

ADORE A19 LAMP

Enjoy consistent and clear lighting with our high performance LED Lamps designed for lasting brilliance. They lower energy consumption while enhancing any environment instantly.



FEATURES

- Dependable performance in fully enclosed environments
- Bright and efficient lighting at 15W producing 1,500 lumens
- 3 variant CCT models: 3000K | 4000K | 5000K
- Operating Temperature: -20°C to +35°C
- Packed in individual color packs – 60 pieces per master pack

WATTAGE	DIMENSIONS(DXH)
9W	2.3" x 4.1"
11W	2.3" x 4.3"
15W	2.5" x 4.8"

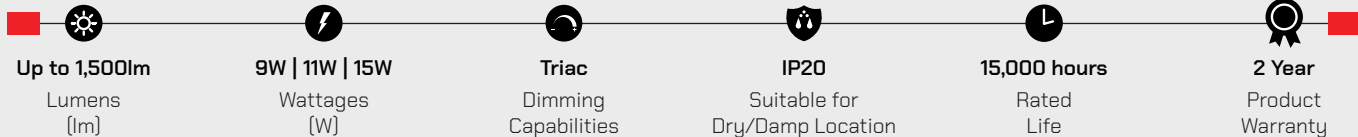

PRODUCT SPECIFICATIONS

PRODUCT NUMBER	PRODUCT WATTAGE [W]	SYSTEM LUMENS [LM]	LUMENS EFFICACY [LM/W]	PRODUCT CCT [K]	INPUT VOLTAGE [V]
HL-A19-9W3K	9W	800lm	89 lm/W	3000K	120 Vac
HL-A19-9W4K	9W	800lm	89 lm/W	4000K	120 Vac
HL-A19-9W5K	9W	800lm	89 lm/W	5000K	120 Vac
HL-A19-11W3K	11W	1,100lm	100 lm/W	3000K	120 Vac
HL-A19-11W4K	11W	1,100lm	100 lm/W	4000K	120 Vac
HL-A19-11W5K	11W	1,100lm	100 lm/W	5000K	120 Vac
HL-A19-15W3K	15W	1,500lm	100 lm/W	3000K	120 Vac
HL-A19-15W4K	15W	1,500lm	100 lm/W	4000K	120 Vac
HL-A19-15W5K	15W	1,500lm	100 lm/W	5000K	120 Vac

EDGE-LIT LED MIRROR

The Edge-lit LED Mirror features a durable, driver-free design with a standard batten, ideal for hotels, motels, apartments, and resorts. Its four battens allow easy single-batten replacement, and if one fails, the remaining three maintain consistent illumination.

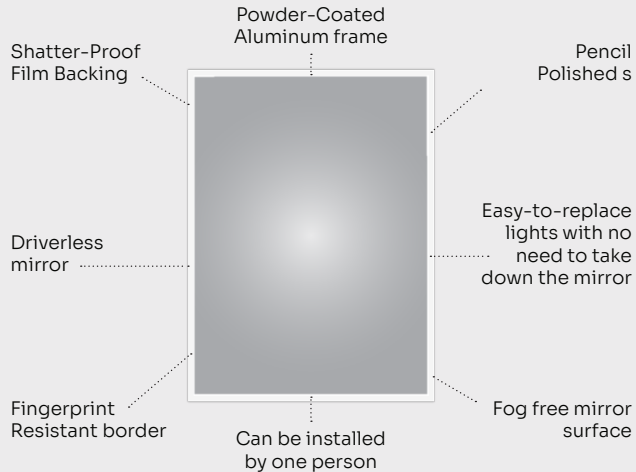

FEATURES

- Zero revenue loss mirror for the hospitality industry
- Condensation-free mirror for a clear view
- Fingerprint-resistant border for easy cleaning
- Anti-rust copper-free glass for durability
- Independent power source for constant light

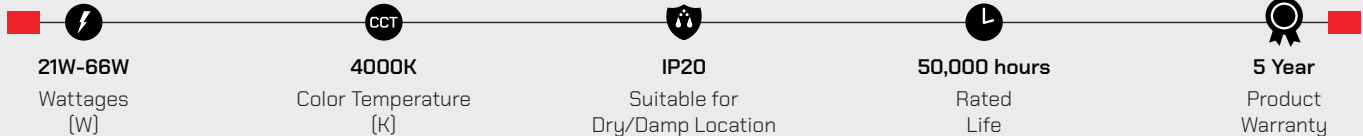

PRODUCT SPECIFICATIONS

PRODUCT NUMBER	PRODUCT WATTAGE (W)	INPUT CURRENT (A)	POWER FACTOR (PF)	LUMENS EFFICACY (LM/W)	PRODUCT CCT (K)	INPUT VOLTAGE (V)
HL-VM-3042 Edgelite Mirror 51W 4K	51W	0.472A	0.9	135 lm/W	4000K	120-277 Vac
HL-VM-3636 Edgelite Mirror 60W 4K	60W	0.556A	0.9	135 lm/W	4000K	120-277 Vac
HL-VM-3642 Edgelite Mirror 60W 4K**	60W	0.555A	0.9	135 lm/W	4000K	120-277 Vac
HL-VM-3648 Edgelite Mirror 66W 4K	66W	0.611A	0.9	135 lm/W	4000K	120-277 Vac
HL-VM-4242 Edgelite Mirror 60W 4K**	60W	0.555A	0.9	135 lm/W	4000K	120-277 Vac
HL-VM-4254 Edgelite Mirror 66W 4K**	66W	0.611A	0.9	135 lm/W	4000K	120-277 Vac
HL-VM-2436 Edgelite Mirror 21W 4K ADA**	21W	0.194A	0.9	135 lm/W	4000K	120-277 Vac
HL-VM-3040 Edgelite Mirror 21W 4K ADA	21W	0.194A	0.9	135 lm/W	4000K	120-277 Vac
HL-VM-4048 Edgelite Mirror 30W 4K ADA**	30W	0.278A	0.9	135 lm/W	4000K	120-277Vac

Additional Accessories: Protecting Cover (HL-VM-Protecting Cover) for Lights.

(** marked is Make to Order)



LED COOLER LIGHT



LED cooler lights are built for low-temperature environments such as coolers and freezers. They deliver bright, efficient illumination while lowering energy use and maintenance needs. When required, up to ten lamps can be connected together in a single series.

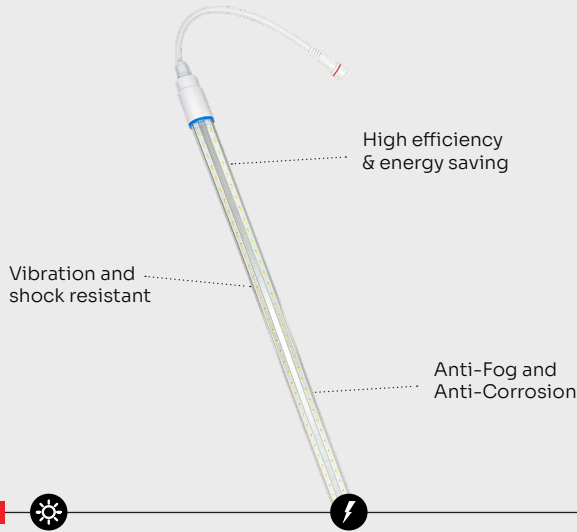

FEATURES

- Provides up to 6,000 lumens with 32W efficacy
- Designed for use in freezers and coolers
- Instant start in cold environments
- Operates between -20°C to +40°C

SIZE	DIMENSIONS(LXWXH)
4FT	47.24" x 1.38" x 1.21"
5FT	59.6" x 1.38" x 1.21"
6FT	70.87" x 1.38" x 1.21"

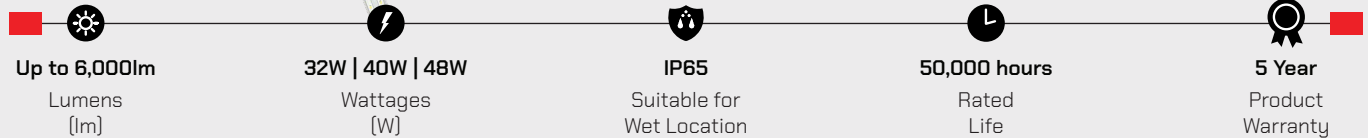

PRODUCT SPECIFICATIONS

PRODUCT NUMBER	PRODUCT WATTAGE [W]	SYSTEM LUMENS [LM]	LUMENS EFFICACY [LM/W]	PRODUCT CCT [K]	INPUT VOLTAGE [V]
HL-CL-32W6K-4 Feet	32W	4,000lm	125 lm/W	6000K	100-277 Vac
HL-CL-40W6K-5 Feet	40W	5,000lm	125 lm/W	6000K	100-277 Vac
HL-CL-48W6K-6 Feet	48W	6,000lm	125 lm/W	6000K	100-277 Vac

Standard In-Box Product Accessories: T-cable, power feed cable and mounting clips.



HAVELLS

**OUR INDUSTRIAL SOLUTIONS ARE CRAFTED
FOR SPACES THAT DEMAND UNWAVERING
PERFORMANCE**



INDUSTRIAL LIGHTING

Linear Highbay	42
Linear Highbay Gen 2.....	44
Flexi Linear Highbay.....	46
Saucer Genx Neo Round Highbay.....	48
Flexi Round Highbay.....	50
Consta Pro LED Strip Light	52
Consta Slim LED Strip Light	54
Endura Pro LED Vapor Tight Strip.....	56
LED Wrap Fixture.....	58



LINEAR HIGHBAY



The Havells LED Linear Highbay ensures up to 50,000 hours of reliable lighting and replaces conventional 400W metal halide or T8 fluorescent tubes. Its durable design prevents discoloration and allows hassle-free sensor installation for added efficiency.

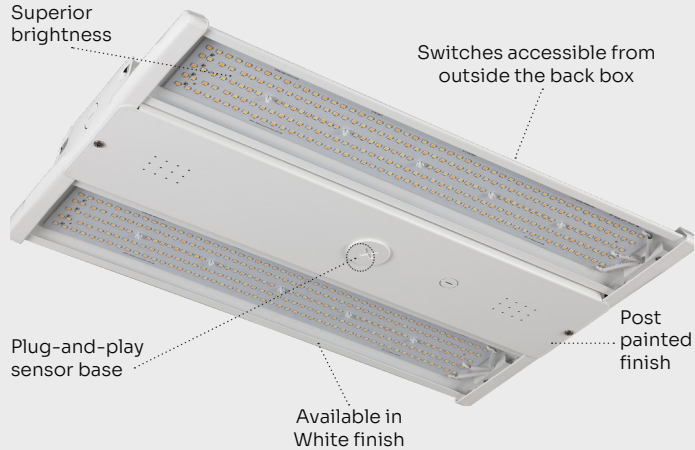

FEATURES

- Selectable CCT & wattage for dry and damp locations
- Port ready for central-mount motion sensor
- Offers 54,000lm in the 400W model for superior brightness
- Pre-drilled for EM (emergency pack) installation
- Operates between -20°C to +50°C

WATTAGE	DIMENSIONS(LXWXH)
115W	19.0" x13" x 1.8"
150W	24.8" x13" x 1.8"
180W	30.8" x13" x 1.8"

WATTAGE	DIMENSIONS(LXWXH)
240W	30.8" x 13" x 1.8"
300W	36.2" x 13" x 1.8"
400W	45.5" x 13" x 1.8"

Up to 54,000lm
Lumens (lm)
 115W-400W
Wattages (W)
 0-10V
Dimming Capabilities
 IP20
Suitable for Dry/Damp Location
 50,000 hours
Rated Life
 5 Year
Product Warranty

PRODUCT SPECIFICATIONS

PRODUCT NUMBER	SELECTABLE WATTAGE [W]	SYSTEM LUMENS [LM]	LUMENS EFFICACY [LM/W]	SELECTABLE CCT [K]	INPUT VOLTAGE [V]
HL-LHB-MW-MCCT-115W	85W/100W/115W	15,525lm	135 lm/W	3000K/4000K/5000K	120-277 Vac
HL-LHB-MW-MCCT-150W	120W/135W/150W	20,250lm	135 lm/W	3000K/4000K/5000K	120-277 Vac
HL-LHB-MW-MCCT-180W	140W/160W/180W	24,300lm	135 lm/W	3000K/4000K/5000K	120-277 Vac
HL-LHB-MW-MCCT-240W	200W/220W/240W	32,400lm	135 lm/W	3000K/4000K/5000K	120-277 Vac
HL-LHB-300W-5K	300W	40,500lm	135 lm/W	5000K	120-277 Vac
HL-LHB-400W-5K	400W	54,000lm	135 lm/W	5000K	120-277 Vac
HL-LHB-300W-5K-HV	300W	40,500lm	135 lm/W	5000K	277-480 Vac
HL-LHB-400W-5K-HV	400W	54,000lm	135 lm/W	5000K	277-480 Vac

Additional Accessories: 20W Remote Emergency Battery Backup (HL-EM-04-01-1), Occupancy Sensor (HL-ANT-6-4R) & RC-100 Sensor Remote Control (Remote-HL-ANT-6-4R).

*MCCT model codes feature selectable CCT options, and MW model codes offer selectable wattage options.

*(Declared Lumens at 5000K at Highest Wattage)

The Havells LED Linear Highbay Gen 2 delivers up to 50,000 hours of dependable lighting, replacing traditional 400W Metal Halide or T8 fluorescent tubes. Built for durability, it resists discoloration and supports easy sensor installation for enhanced efficiency.

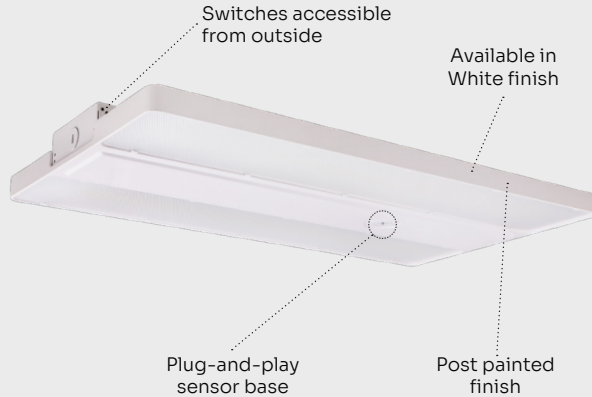

FEATURES

- Selectable CCT & wattage for dry and damp locations
- Motion sensor or emergency driver offered as optional add-ons
- Offers 64,240 lumens in the 440W model for high brightness
- Operates between -40°C to +50°C

WATTAGE	DIMENSIONS(LXWXH)
150W	14.17" x 11.02" x 1.89"
220W	18.11" x 11.81" x 1.89"

WATTAGE	DIMENSIONS(LXWXH)
320W	23.03" x 12.60" x 1.89"
440W	46.06" x 12.60" x 1.89"

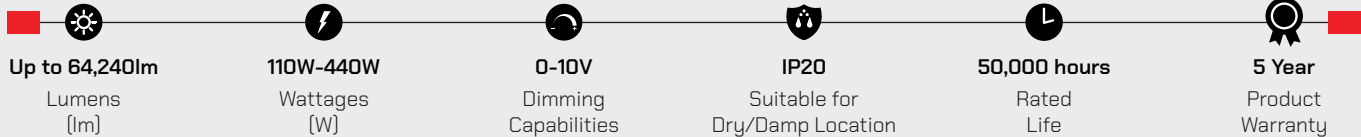

- Up to 64,240lm**
Lumens (lm)
- 110W-440W**
Wattages (W)
- 0-10V**
Dimming Capabilities
- IP20**
Suitable for Dry/Damp Location
- 50,000 hours**
Rated Life
- 5 Year**
Product Warranty

PRODUCT SPECIFICATIONS

PRODUCT NUMBER	SELECTABLE WATTAGE [W]	SYSTEM LUMENS [LM]	LUMENS EFFICACY [LM/W]	SELECTABLE CCT [K]	INPUT VOLTAGE [V]
HL-LHB-MW-MCCT-150W-Gen2	110W/130W/150W	21,900lm	146 lm/W	4000K/5000K	120-277 Vac
HL-LHB-MW-MCCT-220W-Gen2	180W/200W/220W	32,120lm	146 lm/W	4000K/5000K	120-277 Vac
HL-LHB-MW-MCCT-320W-Gen2	280W/300W/320W	46,720lm	146 lm/W	4000K/5000K	120-277 VAC
HL-LHB-MW-MCCT-440W-Gen2	380W/400W/440W	64,240lm	146 lm/W	4000K/5000K	120-277 VAC
HL-LHB-MW-MCCT-320W-HV-Gen2**	280W/300W/320W	46,720lm	146 lm/W	4000K/5000K	277-480 Vac
HL-LHB-MW-MCCT-440W-HV-Gen2**	380W/400W/440W	64,240lm	146 lm/W	4000K/5000K	277-480 Vac

Additional Accessories: 20W Remote Emergency Battery Backup (HL-EM-04-01-1), Occupancy Sensor (HL-ANT-6-4R) & RC-100 Sensor Remote Control (Remote-HL-ANT-6-4R).

(** marked is Make to Order)

*(Declared Lumens at 4000K at Highest Wattage)



FLEXI LINEAR HIGHBAY



The Flexi Linear Highbay offers exceptional versatility, allowing you to customize wattage, color temperature, and beam angles to provide ideal lighting for any industrial or commercial environment.

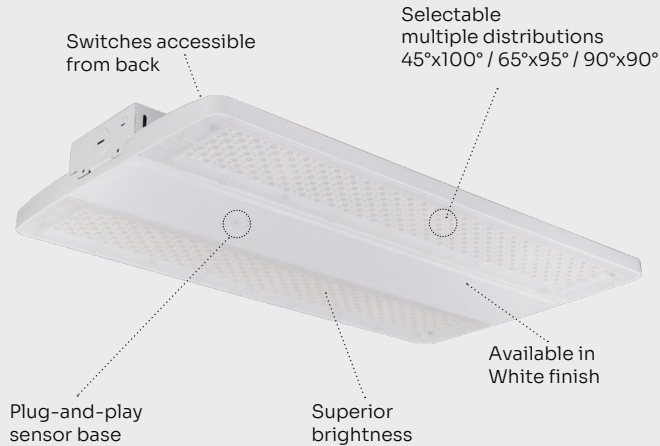

Selectable Beam

FEATURES

- Delivers high efficacy in 320W light providing up to 48,000lm
- Fully selectable output, color temperature and beam angle
- Supports dimming for enhanced control
- Operates from -40°C to +50°C

WATTAGE	DIMENSIONS(LXWXH)
165W	15.0" x 11.0" x 1.89"
240W	20.0" x 11.0" x 1.89"
320W	22.0" x 12.1" x 1.89"

Up to 48,000lm
Lumens (lm)

105W-320W
Wattages (W)

0-10V
Dimming Capabilities

IP20
Suitable for Dry/Damp Location

50,000 hours
Rated Life

5 Year
Product Warranty

PRODUCT SPECIFICATIONS

PRODUCT NUMBER	SELECTABLE WATTAGE [W]	SYSTEM LUMENS [LM]	LUMENS EFFICACY [LM/W]	SELECTABLE CCT [K]	INPUT VOLTAGE [V]
HL-LHB-MW-MCCT-ML3-165W**	105W/130W/165W	24,750lm	150 lm/W	3500K/4000K/5000K	120-347 Vac
HL-LHB-MW-MCCT-ML3-240W	165W/215W/240W	36,000lm	150 lm/W	3500K/4000K/5000K	120-347 Vac
HL-LHB-MW-MCCT-ML3-320W**	280W/300W/320W	48,000lm	150 lm/W	3500K/4000K/5000K	120-347 Vac
HL-LHB-MW-MCCT-ML3-320W-HV**	280W/300W/320W	48,000lm	150 lm/W	3500K/4000K/5000K	277-480 Vac

Additional Accessories: 20W Remote Emergency Battery Backup (HL-EM-04-01-1), Occupancy Sensor (HL-ANT-6-4R) & RC-100 Sensor Remote Control (Remote-HL-ANT-6-4R).

(** marked is Make to Order)

*(Declared Lumens at 4000K and 65°X95°)

SAUCER GENX NEO ROUND HIGHBAY

The Saucer Genx Neo Round Highbay now supports sensors with a plug-and-play feature. Its efficiency and adaptability makes it the ideal solution for high-ceiling environments.



FEATURES

- 210W fixture delivering up to 28,350lm
- Selectable CCT & wattage for dry and damp locations
- Customisable dimming capabilities
- Operates between -20°C to +50°C

WATTAGE	DIMENSIONS(DXH)
130W	9.20" x 6.1"
160W	10.6" x 6.6"
210W	11.8" x 6.4"

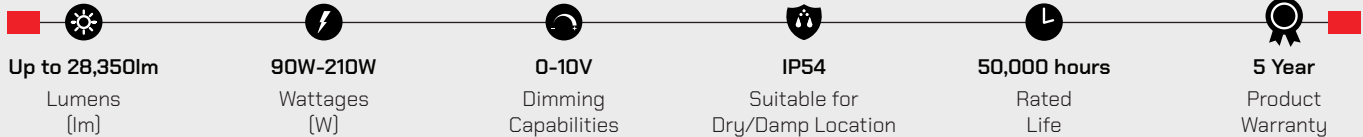

- Up to 28,350lm**
Lumens (lm)
- 90W-210W**
Wattages (W)
- 0-10V**
Dimming Capabilities
- IP54**
Suitable for Dry/Damp Location
- 50,000 hours**
Rated Life
- 5 Year**
Product Warranty

PRODUCT SPECIFICATIONS

PRODUCT NUMBER	SELECTABLE WATTAGE (W)	SYSTEM LUMENS (LM)	LUMENS EFFICACY (LM/W)	SELECTABLE CCT (K)	INPUT VOLTAGE (V)
HL-RHB-MW-MCCT-130W	90W/110W/130W	17,550lm	135 lm/W	3000K/4000K/5000K	120-277 Vac
HL-RHB-MW-MCCT-160W	120W/140W/160W	21,600lm	135 lm/W	3000K/4000K/5000K	120-277 Vac
HL-RHB-MW-MCCT-210W	170W/190W/210W	28,350lm	135 lm/W	3000K/4000K/5000K	120-277 Vac

Additional Accessories: 40W Remote Emergency Battery Backup (HL-EM-07-01-1), Occupancy Sensor (HL-ANT-6-4R), RC-100 Sensor Remote Control (Remote-HL-ANT-6-4R) and J Hook (HL-RHB-MW-MCCT-J hook).

*(Declared Lumens at 4000K at Highest Wattage)



FLEXI ROUND HIGHBAY



The Flexi Round Highbay is a highly versatile lighting solution featuring fully selectable wattage, color temperature, and beam angles to perfectly tailor illumination for any industrial or commercial space .

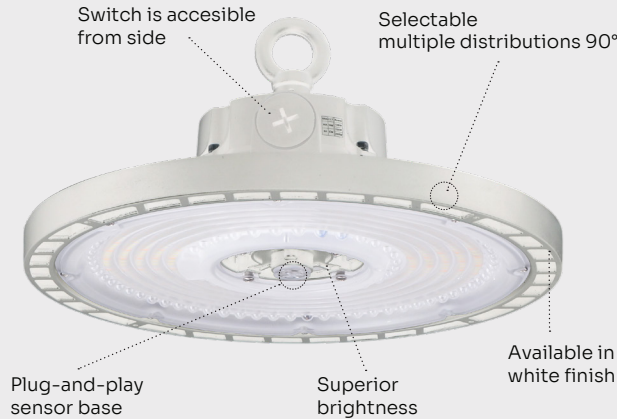

Selectable Beam

FEATURES

- Delivers high efficacy in 300W light providing up to 48,000lm
- Fully selectable output, color temperature and beam angle
- Supports dimming for enhanced control
- Operates from -40°C to +50°C

WATTAGE	DIMENSIONS(DXH)
200W	11.81" x 5.75"
300W	13.80" x 5.83"

Up to 48,300lm	200W-300W	0-10V	IP 65	50,000 hours	5 Year
Lumens (lm)	Wattages (W)	Dimming Capabilities	Suitable for Wet Location	Rated Life	Product Warranty

PRODUCT SPECIFICATIONS

PRODUCT NUMBER	SELECTABLE WATTAGE [W]	SYSTEM LUMENS [LM]	LUMENS EFFICACY [LM/W]	SELECTABLE CCT [K]	INPUT VOLTAGE [V]
HL-RHB-MW-MCCT-ML2-200W	120W/150W/200W	32,400lm	162 lm/W	4000K/5000K	120-277 Vac
HL-RHB-MW-MCCT-ML2-300W	200W/240W/300W	48,300lm	161 lm/W	4000K/5000K	120-277 Vac
HL-RHB-MW-MCCT-ML2-300W-HV**	200W/240W/300W	48,300lm	161 lm/W	4000K/5000K	200-480 Vac

Additional Accessories: 40W Remote Emergency Battery Backup (HL-EM-07-01-1), Occupancy Sensor (HL-ANT-6-4R), RC-100 Sensor Remote Control (Remote-HL-ANT-6-4R), J Hook (HL-RHB-MW-MCCT-ML2-J hook), Aluminium Reflector (HL-RHB-MW-MCCT-ML2-Reflector), Junction Box Adaptor (HL-RHB-MW-MCCT-ML2-JB Adapter), Mounting Bracket (HL-RHB-MW-MCCT-ML2-Mounting Bracket), 1/2 NPT Adaptor (HL-RHB-1/2 NPT Adaptor) and 3/4 NPT Adaptor (HL-RHB-1/2 NPT Adaptor).

(** marked is Make to Order)

*(Declared Lumens at 4000K and 60°)



CONSTA PRO LED STRIP LIGHT



The Havells Consta Pro LED Strip Series comes in 2', 4', and 8' lengths, built for both dry and damp conditions. Its sturdy powder-coated body offers selectable CCT and wattage for effortless customization and versatile lighting.

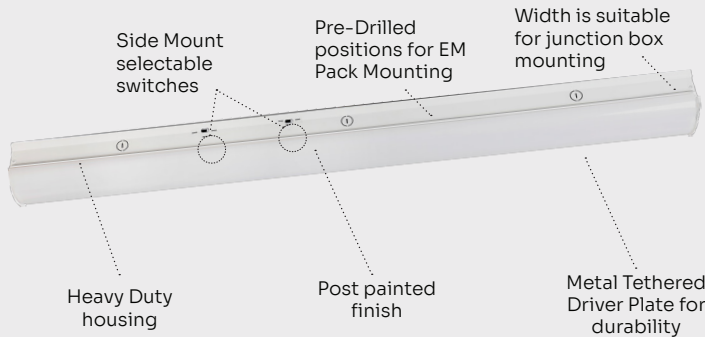

FEATURES

- Selectable CCT & wattage for dry and damp locations
- Available in three variant sizes - 2ft, 4ft & 8ft
- Dimming capabilities enables energy-efficient performance
- 50,000-hour rated life with 5-year warranty

SIZE	DIMENSIONS(LXWXH)
2FT	23.6" x 4.4" x 3.8"
4FT	48.0" x 4.4" x 3.8"
8FT	93.0" x 4.4" x 3.8"

Up to 10,400lm	12W-80W	0-10V	IP20	50,000 hours	5 Year
Lumens (lm)	Wattages (W)	Dimming Capabilities	Suitable for Dry/Damp Location	Rated Life	Product Warranty

PRODUCT SPECIFICATIONS

PRODUCT NUMBER	SELECTABLE WATTAGE [W]	SYSTEM LUMENS [LM]	LUMENS EFFICACY [LM/W]	SELECTABLE CCT [K]	INPUT VOLTAGE [V]
HL-STW-MW-MCCT-23W-2 Feet**	12W/18W/23W	2,990lm	130 lm/W	3500K/4000K/5000K	120-277 Vac
HL-STW-MW-MCCT-46W-4 Feet	23W/35W/46W	5,980lm	130 lm/W	3500K/4000K/5000K	120-277 Vac
HL-STW-MW-MCCT-80W-8 Feet	40W/60W/80W	10,400lm	130 lm/W	3500K/4000K/5000K	120-277 Vac

Additional Accessories: Remote Emergency Battery Backup (HL-EM-01-01-1), Suspension Kit (HL-STW-Suspension Kit), Connecting Plate (HL-STW-Connecting Plate), Occupancy Sensor (PIR-201HB-8A) and Decorative End Cap (HL-STW-Deco End Cap) are ordered separately.

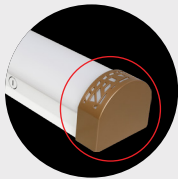

LED Strip with
Decorative End Cap
(Sold Separately).

(** marked is Make to Order)

*(Declared Lumens at 5000K at Highest Wattage)



CONSTA SLIM LED STRIP LIGHT



The Consta Slim LED Strip Light is a steel-based fixture boasting of a pristine white powder coating and offering a comprehensive range of LED options suitable for dry and damp environments.

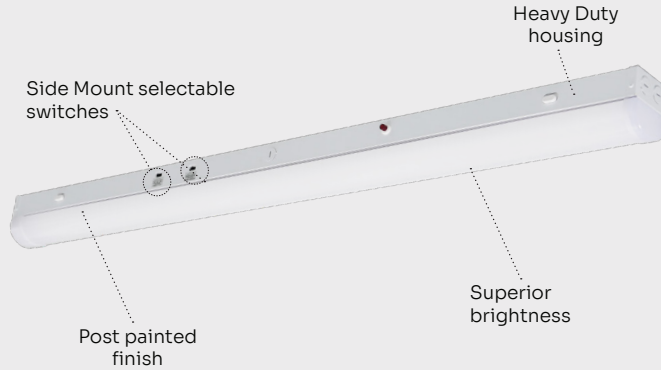

FEATURES

- Provides up to 11,600 lumens for powerful, even brightness
- Adjustable CCT and wattage allow for precise lighting control
- Dimming capabilities enables energy-efficient performance
- 50,000-hour rated life with 5-year warranty

SIZE	DIMENSIONS(LXWXH)
2FT	24" x 3.25" x 3.15"
4FT	48" x 3.25" x 3.15"
8FT	96" x 3.25" x 3.15"

Up to 11,600lm	15W-80W	0-10V	IP20	50,000 hours	5 Year
Lumens (lm)	Wattages (W)	Dimming Capabilities	Suitable for Dry/Damp Location	Rated Life	Product Warranty

PRODUCT SPECIFICATIONS

PRODUCT NUMBER	SELECTABLE WATTAGE [W]	SYSTEM LUMENS [LM]	LUMENS EFFICACY [LM/W]	SELECTABLE CCT [K]	INPUT VOLTAGE [V]
HL-STM-MW-MCCT-20W-2 Feet**	15W/20W/25W	3,625lm	140 lm/W	3000K/4000K/5000K	100-277 Vac
HL-STM-MW-MCCT-40W-4 Feet	20W/30W/40W	5,800lm	140 lm/W	3000K/4000K/5000K	100-277 Vac
HL-STM-MW-MCCT-80W-8 Feet	60W/70W/80W	11,600lm	140 lm/W	3000K/4000K/5000K	100-277 Vac

Standard In-Box Product Accessories: Remote Emergency Battery Backup (HL-EM-01-01-1) and 1 pin Motion Sensor Base.

Additional Accessories: Link Cable (HL-STM-LC), Surface mount joining plate (HL-STM-SML), Pendant mount joining plate (HL-STM-PMLP) and Sensor (HL-STM-SENSOR) are ordered separately.

(** marked is Make to Order)

*(Declared Lumens at 4000K at Highest Wattage)

ENDURA PRO LED VAPOR TIGHT STRIP

Built to perform in wet and demanding conditions, the Endura Pro LED Vapor Tight Strip offers superior energy efficiency and endurance. Its impact-resistant body with opal cover supports adjustable CCT and wattage settings for versatile lighting applications.



FEATURES

- 8' model delivers up to 15,300 lumens with high efficacy
- Adjustable CCT and wattage for tailored lighting
- Supports dimming for enhanced control
- Operates reliably from -40°C to +50°C

SIZE-WATTAGE	DIMENSIONS(LXWXH)
2FT-30W	23.62" x 4.33" x 3.54"
4FT-48W	47.20" x 4.80" x 3.10"
4FT-50W	47.24" x 4.33" x 3.54"
8FT-100W	94.48" x 4.33" x 3.54"

					
Up to 15,300lm Lumens (lm)	10W-100W Wattages (W)	0-10V Dimming Capabilities	IP65 Suitable for Wet Location	50,000 hours Rated Life	5 Year Product Warranty

PRODUCT SPECIFICATIONS

PRODUCT NUMBER	SELECTABLE WATTAGE [W]	SYSTEM LUMENS [LM]	LUMENS EFFICACY [LM/W]	SELECTABLE CCT [K]	INPUT VOLTAGE [V]
HL-VT-MW-MCCT-30W-2 Feet**	10W/20W/30W	4,590lm	153 lm/W	3000K/3500K/4000K/4500K/5000K	120-277 Vac
HL-VT-MW-MCCT-48W-4 Feet	36W/42W/48W	6,240lm	130 lm/W	3000K/4000K/5000K	120-277 Vac
HL-VT-MW-MCCT-100W-8 Feet**	60W/80W/100W	15,300lm	153 lm/W	3000K/3500K/4000K/4500K/5000K	120-277 Vac

Additional Accessories: Remote Emergency Battery Backup (HL-EM-06-01-1).

(** marked is Make to Order)

*(Declared Lumens at 4000K at Highest Wattage)



LED WRAP FIXTURE



A versatile LED Wrap Fixture built with heavy-duty steel housing and a precise beam angle for consistent output. Four selectable wattage and Five color temperature make it adaptable for a wide range of indoor environments.

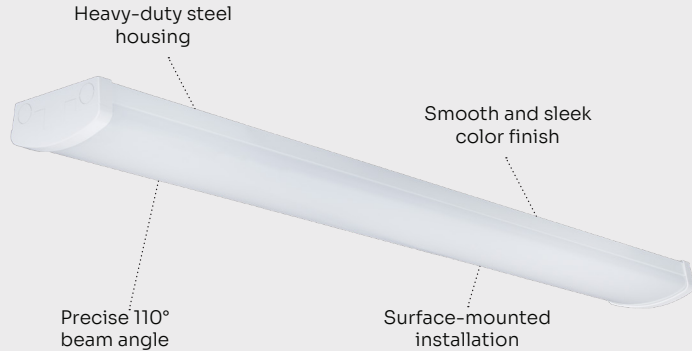

FEATURES

- High efficacy with the 8' light delivers 12,000 lumens
- Adjustable 5 CCT and 4 Wattage for tailored lighting
- Available in three variant sizes- 2ft, 4ft and 8ft
- Operates between -20°C to +50°C

SIZE	DIMENSIONS(LXWXH)
2FT	24.4" x 2.4" x 5.5"
4FT	47.6" x 2.4" x 5.5"
8FT	93.8 "x 2.4" x 5.5"

Up to 9000lm	12W-25W	0-10V	IP65	100,000 hours	5 Year
Lumens (lm)	Wattages (W)	Dimming Capabilities	Suitable for Wet Location	Rated Life	Product Warranty

PRODUCT SPECIFICATIONS

	SELECTABLE WATTAGE	SYSTEM LUMENS	LUMENS EFFICACY	SELECTABLE CCT
PRODUCT NUMBER	[W]	[LM]	[LM/W]	[K]
★ HL-WA-4MW-5MCCT-25W-2 Feet**	12W/16W/20W/25W	3,100lm	125 lm/W	3000K/3500K/4000K/5000K/6500K
★ HL-WA-4MW-5MCCT-46W-4 Feet	24W/31W/38W/46W	5,750lm	125 lm/W	3000K/3500K/4000K/5000K/6500K
★ HL-WA-4MW-5MCCT-72W-8 Feet**	38W/50W/64W/72W	9,000lm	125 lm/W	3000K/3500K/4000K/5000K/6500K

Additional Accessories: Cable suspension kit (HL-WA-Cable suspension kit), End-to-end connector kit(HL-WA-End-to-end connector kit), Connection plate (HL-WA-Connection plate) and 1 foot linking cord (HL-WL-1 foot linking cord).

(** marked is Make to Order)

(★ marked is available from Quarter 3)

*(Declared Lumens at 4000K at Highest Wattage)



HAVELLS

**OUTDOOR SPACES DEMAND LIGHTING THAT
PERFORMS FLAWLESSLY UNDER
— ANY CONDITION —**





| OUTDOOR LIGHTING

Flexi Lite Area Light	62
Jeta Flare Flood Light.....	64
Flexi Flood Light.....	66
Bullet Flood Light.....	68
Hexa Mini Wall Pack.....	70
Hexa Half-Cut Wall Pack	72
Hexa Half-Cut Wall Pack Gen 2	74
LED Parking Garage Light.....	76
LED Canopy Light	78
LED Post Top Light	80
Up & Down Wall Sconce	82
LED Corn Lamp.....	84
LED Sport Light.....	86
Interchangeable Bollard.....	88
Domed Aluminum Bollard	90
Square Aluminum Bollard	91

FLEXI LITE AREA LIGHT

The Flexi Lite Area Light is an all-in-one solution in one box, offering adjustable lumen output, CCT, and beam options. It features built-in surge protection, an easy mounting system, and supports Type III, IV, and V light distributions for versatile and comprehensive performance.

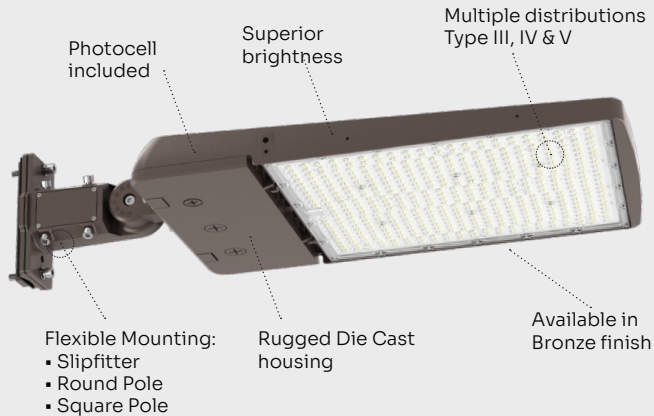

Selectable
Beam

FEATURES

- Delivers high efficacy in 120W light providing up to 48,000lm
- Fully selectable output, color temperature and beam angle
- Supports dimming for enhanced control
- Operates from -40°C to +50°C

WATTAGE	DIMENSIONS(LXWXH)
150W	10.72" x 27.12" x 6.45"
300W	14.12" x 31.12" x 6.45"



Up to 48,000lm
Lumens
(lm)



70W-300W
Wattages
(W)



0-10V
Dimming
Capabilities



IP65
Suitable for
Wet Location



50,000 hours
Rated
Life



5 Year
Product
Warranty

PRODUCT NUMBER	SELECTABLE WATTAGE [W]	SYSTEM LUMENS [LM]	LUMENS EFFICACY [LM/W]	SELECTABLE CCT [K]	INPUT VOLTAGE [V]
HL-AL-MW-MCCT-ML3-150W-BR-PS	70W/100W/150W	24,000lm	160 lm/W	3000K/4000K/5000K	120-277 Vac
HL-AL-MW-MCCT-ML3-300W-BR-PS	200W/240W/300W	48,000lm	160 lm/W	3000K/4000K/5000K	200-480 Vac
HL-AL-MW-MCCT-ML3-150W-BR-HV	70W/100W/150W	24,000lm	160 lm/W	3000K/4000K/5000K	120-277 Vac
HL-AL-MW-MCCT-ML3-300W-BR-HV	200W/240W/300W	48,000lm	160 lm/W	3000K/4000K/5000K	200-480 Vac

Standard Product Accessories:

*(In-Box Accessories in PS Code Only): 10kV SPD, 3-Pin Socket, Photocell, Shorting Cap, Universal Adapter (Slip Fitter, Square/Round Pole Mount).

*(In-Box Accessories in HV Code Only): 10KV SPD, 3-Pin Socket, Shorting Cap, Universal Adapter (Slip Fitter, Square | Round Pole Mount).

Additional Accessories: Yoke Mount Bracket (HL-AL-YM), Shorting Cap (HL-AL-SC), 3 Pin Photocell (HL-AL-HV-PS), Visor (HL-AL-HV-Visor), and Trunnion Mount Bracket (HL-AL-YM) are ordered separately.

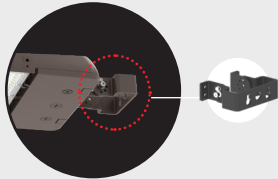

Area Light with Yoke Mount Bracket (HL-AL-YM).

*(Declared Lumens at 4000K at Highest Wattage)

JETA FLARE FLOOD LIGHT

Built with die-cast aluminium housing, Jeta Flare Flood Lights are sustainable and long-lived. They allow CCT and wattage customization through a slide switch and support dimming for personalized lighting.

Available in bronze finish

Integrated On/Off photocell

Knuckle or Bracket Mount available



Wattage and CCT selection switch

Die-Cast aluminum housing



FEATURES

- Fully selectable CCT & wattage for maximum control
- Make to order color options: black and white
- Dimming control for flexible lighting
- Operates between -40°C to +45°C

WATTAGE	DIMENSIONS(LXWXH)
60W	8.3" x 9.1" x 1.8"
100W	10.3" x 8.9" x 2.7"
150W	11.4" x 9.7" x 2.9"

Up to 21,000lm	40W-150W	0-10V	IP65	50,000 hours	5 Year
Lumens (lm)	Wattages (W)	Dimming Capabilities	Suitable for Wet Location	Rated Life	Product Warranty

PRODUCT SPECIFICATIONS

PRODUCT NUMBER	SELECTABLE WATTAGE [W]	SYSTEM LUMENS [LM]	LUMENS EFFICACY [LM/W]	SELECTABLE CCT [K]	INPUT VOLTAGE [V]
HL-FL-MW-MCCT-60W-Screw Base	40W/50W/60W	8,400lm	140 lm/W	3000K/4000K/5000K	120-277 Vac
HL-FL-MW-MCCT-60W-C Clamp	40W/50W/60W	8,400lm	140 lm/W	3000K/4000K/5000K	120-277 Vac
HL-FL-MW-MCCT-100W-C Clamp	60W/80W/100W	14,000lm	140 lm/W	3000K/4000K/5000K	120-277 Vac
HL-FL-MW-MCCT-150W-C Clamp	100W/120W/150W	21,000lm	140 lm/W	3000K/4000K/5000K	120-277 Vac



Jeta Small: 60W



Jeta Medium: 100W



Jeta Large: 150W

*(Declared Lumens at 4000K at Highest Wattage)

FLEXI FLOOD LIGHT

Our Flexi Flood Light Series delivers powerful, uniform illumination designed for a wide range of outdoor and industrial applications. Built with high-efficiency and a durable die-cast aluminum housing, each model offers selectable wattage and CCT options for maximum flexibility.



FEATURES

- 320W model delivers up to 45,000 lumens with high efficacy
- Fully selectable features for any environment
- Selectable Beam angle (7H6V / 6H6V / 5H5V)
- Suitable for -40°C to +50°C temperatures

WATTAGE	DIMENSIONS(LXWXH)
80W	10.9" x 7.8" x 3.62"
150W	13.62" x 9.36" x 5.57"
300W	17.66" x 12.18" x 9.22"

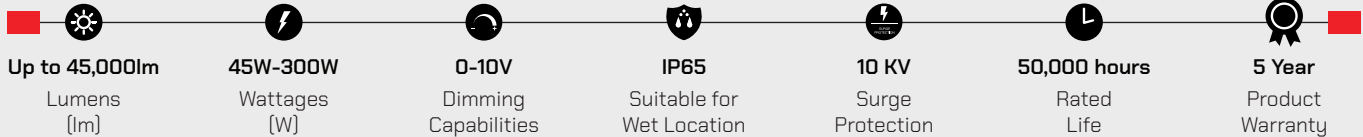

PRODUCT NUMBER	SELECTABLE WATTAGE [W]	SYSTEM LUMENS [LM]	LUMENS EFFICACY [LM/W]	SELECTABLE CCT [K]	INPUT VOLTAGE [V]
HL-FL-MW-MCCT-ML3-80W	45W/60W/80W	12,000lm	150 lm/W	3000K/4000K/5000K	120-277 Vac
HL-FL-MW-MCCT-ML3-150W	100W/120W/150W	22,500lm	150 lm/W	3000K/4000K/5000K	120-277 Vac
HL-FL-MW-MCCT-ML3-300W	200W/240W/300W	45,000lm	150 lm/W	3000K/4000K/5000K	120-277 Vac
HL-FL-MW-MCCT-ML3-150W-HV	100W/120W/150W	22,000lm	147 lm/W	3000K/4000K/5000K	277-480 Vac
HL-FL-MW-MCCT-ML3-300W-HV	200W/240W/300W	45,000lm	150 lm/W	3000K/4000K/5000K	277-480 Vac

Standard Mounting:

80W - Knuckle Mount & C Bracket

150W - Slip Fitter & C Bracket

300W - Slip Fitter & Trunnion Mount



Flexi Small: 80W



Flexi Medium: 150W



Flexi Large: 300W

*(Declared Lumens at 4000K at Highest Wattage)



BULLET FLOOD LIGHT



Our Bullet Flood Light Series delivers powerful, uniform illumination designed for a wide range of outdoor and industrial applications. Built with high-efficiency performance and a durable die-cast aluminum housing

Effective heat dissipation design

Durable Die-Cast aluminum housing



Sturdy Mounting:
▪ Knuckle Mount

Available in Bronze finish



FEATURES

- 25W model delivers up to 3,625 lumens with high efficacy
- Fully selectable suitable for small-area outdoor applications
- Compact, lightweight, and easy to install
- Suitable for -40°C to +50°C temperatures

WATTAGE	DIMENSIONS(DXL)
25W	4.06" x 6.35"

Up to 3,625lm	13W/20W/25W	0-10V	IP65	50,000 hours	5 Year
Lumens (lm)	Wattages (W)	Dimming Capabilities	Suitable for Wet Location	Rated Life	Product Warranty

PRODUCT SPECIFICATIONS

PRODUCT NUMBER	SELECTABLE WATTAGE [W]	SYSTEM LUMENS [LM]	LUMENS EFFICACY [LM/W]	SELECTABLE CCT [K]	INPUT VOLTAGE [V]
HL-FL-MW-MCCT-25W	13W/20W/25W	3,625lm	145 lm/W	3000K/4000K/5000K	120-277 Vac

Standard Mounting: Knuckle Mount.

Additional Accessories: Ground Plug(HL-FL-MW-MCCT-25W-Ground Plug).

*(Declared Lumens at 4000K at Highest Wattage)

HEXA MINI WALL PACK

Crafted with a sleek, compact design, the Hexa Mini Wall Packs offer both sophistication and performance. They enhance outdoor environments through precise illumination and minimal light spillage.



FEATURES

- High-efficacy 24W provides up to 3,000 lumens
- Fully selectable output and color temperature
- Reliable in all weather conditions
- Operates from -20°C to +55°C

WATTAGE	DIMENSIONS(LXWXH)
24W	9.0" x 6.5" x 3.1"

					
Up to 3,000lm	12W/18W/24W	0-10V	IP65	50,000 hours	5 Year
Lumens (lm)	Wattages (W)	Dimming Capabilities	Suitable for Wet Location	Rated Life	Product Warranty

PRODUCT SPECIFICATIONS

PRODUCT NUMBER	SELECTABLE WATTAGE [W]	SYSTEM LUMENS [LM]	LUMENS EFFICACY [LM/W]	SELECTABLE CCT [K]	INPUT VOLTAGE [V]
HL-WP-MW-MCCT-24W	12W/18W/24W	3,000lm	≥125 lm/W	3000K/4000K/5000K	120-277 Vac
HL-WP-MW-MCCT-24W-PS	12W/18W/24W	3,000lm	≥125 lm/W	3000K/4000K/5000K	120-277 Vac

*(Declared Lumens at 4000K at Highest Wattage)

HALF-CUT WALL PACK

The Hexa Half-Cut Wall Pack feature a modern design and advanced lighting technology that deliver efficient, focused illumination with minimal light spill. They retain the same size as traditional HID wall packs, making replacements quick and simple.



FEATURES

- High efficacy performance up to 14,400 lumens
- Fully selectable output and color temperature
- Works efficiently in temperatures from -20°C to +40°C
- Long 50,000-hour lifespan

WATTAGE	DIMENSIONS(LXWXH)
75W	12.95" x 9.9" x 5.4"
120W	12.95" x 9.9" x 5.4"



- Up to 14,400lm**
Lumens (lm)
- 45W-120W**
Wattages (W)
- 0-10V**
Dimming Capabilities
- IP65**
Suitable for Wet Location
- 50,000 hours**
Rated Life
- 5 Year**
Product Warranty

PRODUCT SPECIFICATIONS

PRODUCT NUMBER	SELECTABLE WATTAGE [W]	SYSTEM LUMENS [LM]	LUMENS EFFICACY [LM/W]	SELECTABLE CCT [K]	INPUT VOLTAGE [V]
HL-WP-MW-MCCT-75W-PS	45W/60W/75W	9,000lm	≥120 lm/W	3000K/4000K/5000K	120-277 Vac
HL-WP-MW-MCCT-120W-PS	72W/96W/120W	14,400lm	≥120 lm/W	3000K/4000K/5000K	120-277 Vac

*(Declared Lumens at 4000K at Highest Wattage)

HEXA HALF-CUT WALL PACK GEN 2

The Half-Cut Wall Pack Gen 2 is a tough solution for outdoor environments. It's available in three variants: with an integrated photocell, a photocell that includes an emergency driver, and a high-voltage photocell with an emergency driver.



FEATURES

- Delivers high efficacy in 120W light providing up to 18,120lm
- Fully selectable output and color temperature
- Stripe-glass diffuser for controlled distribution
- Reliable operation from -40°C to +50°C

WATTAGE	DIMENSIONS(LXWXH)
120W	14.2" x 8.6" x 6.5"

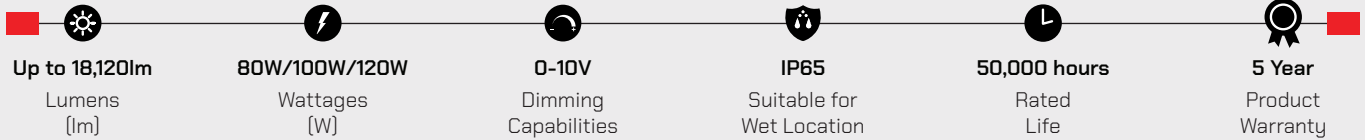

PRODUCT SPECIFICATIONS

PRODUCT NUMBER	SELECTABLE WATTAGE (W)	SYSTEM LUMENS (LM)	LUMENS EFFICACY (LM/W)	SELECTABLE CCT (K)	INPUT VOLTAGE (V)
HL-WP-MW-MCCT-120W-PS-Gen2	80W/100W/120W	18,120lm	151 lm/W	3000K/4000K/5000K	120-277 Vac
HL-WP-MW-MCCT-120W-PS-BB-Gen2	80W/100W/120W	18,120lm	151 lm/W	3000K/4000K/5000K	120-277 Vac
HL-WP-MW-MCCT-120W-PS-HV-Gen2	80W/100W/120W	17,620lm	147 lm/W	3000K/4000K/5000K	277-480Vac

*The BB model code features an inbuilt emergency battery backup, and the HV model code offers high-voltage options.

*(Declared Lumens at 4000K at Highest Wattage)

LED PARKING GARAGE LIGHT



Our LED Parking Garage lights deliver reliable performance and exceptional illumination for parking lots. Designed with energy-efficient LEDs and long-lasting durability, they improve visibility while adding a clean, modern aesthetic to any space.



FEATURES

- Provides 75W brightness with up to 10,875 lumens
- Fully selectable with 160° fixed beam angle
- Works reliably in -30°C to +50°C temperatures
- Instant start, No flickering, No humming

WATTAGE	DIMENSIONS(LXWXH)
40W	8.03" x 8.03" x 3.66"
75W	10.0" x 10.0" x 4.17"

- Up to 10,875lm**
Lumens (lm)
- 20W-75W**
Wattages (W)
- 0-10V**
Dimming Capabilities
- IP65**
Suitable for Wet Location
- 50,000 hours**
Rated Life
- 5 Year**
Product Warranty

PRODUCT SPECIFICATIONS

PRODUCT NUMBER	SELECTABLE WATTAGE [W]	SYSTEM LUMENS [LM]	LUMENS EFFICACY [LM/W]	SELECTABLE CCT [K]	INPUT VOLTAGE [V]
HL-CP-MW-MCCT-40W	20W/30W/40W	6,000lm	150 lm/W	3000K/4000K/5000K	120-277 Vac
HL-CP-MW-MCCT-75W	40W/60W/75W	10,875lm	145 lm/W	3000K/4000K/5000K	120-277 Vac

Additional Accessories: Motion sensor (HL-CP-MS).

*(Declared Lumens at 4000K at Highest Wattage)

LED CANOPY LIGHT

Our Canopy Lights offer dependable performance and superior illumination for gas stations. With LED efficiency and lasting quality, they enhance visibility and add aesthetic appeal to every space.

Rugged Die Cast housing

Suitable for Junction Box mounting

Compact design

Available in White finish



FEATURES

- Provides 120W brightness with up to 22,500 lumens
- Instant start, no flickering, no humming
- Long 50,000-hour lifespan
- Works reliably in -40°C to +50°C temperatures

WATTAGE	DIMENSIONS(LXWXH)
120W	9.0" x 6.5" x 3.1"
150W	9.0" x 6.5" x 3.1"



22,500lm
Lumens
(lm)



120W | 150W
Wattages
(W)



0-10V
Dimming
Capabilities



IP65
Suitable for
Wet Location



50,000 hours
Rated
Life



5 Year
Product
Warranty

PRODUCT SPECIFICATIONS

PRODUCT NUMBER	PRODUCT WATTAGE [W]	SYSTEM LUMENS [LM]	LUMENS EFFICACY [LM/W]	PRODUCT CCT [K]	INPUT VOLTAGE [V]
HL-CP-120W5K	120W	22,500lm	132 lm/W	5000K	120-277 Vac
HL-CP-150W5K	150W	18,360lm	153 lm/W	5000K	120-277 Vac

Additional Accessories: Mounting plate (HL-CP-SF Mounting Plate).



LED POST TOP LIGHT



The LED Post Top Light offers uniform, comfortable lighting for pathways and landscaped areas. With selectable CCT, adjustable wattage, durable housing, IP65 protection, and efficient Lumileds LEDs, it delivers reliable, modern outdoor illumination



FEATURES

- High efficacy with 150W light delivers 19,800 lumens
- Fully selectable wattage and color temperature
- Dimming control for flexible lighting
- Operates between -40°C to +50°C

WATTAGE	DIMENSIONS(DXH)
75W	14.96" x 23.33"
150W	20.9" x 23.58"

Up to 19,800lm	35W-150W	0-10V	IP65	50,000 hours	5 Year
Lumens (lm)	Wattages (W)	Dimming Capabilities	Suitable for Wet Location	Rated Life	Product Warranty

PRODUCT SPECIFICATIONS

PRODUCT NUMBER	SELECTABLE WATTAGE [W]	SYSTEM LUMENS [LM]	LUMENS EFFICACY [LM/W]	SELECTABLE CCT [K]	INPUT VOLTAGE [V]
HL-PT-MW-MCCT-75W	35W/50W/75W	10,350lm	138 lm/W	3000K/4000K/5000K	120-277 Vac
HL-PT-MW-MCCT-150W**	100W/125W/150W	19,800lm	132 lm/W	3000K/4000K/5000K	120-277 Vac



Small Post Top Light: 75W



Large Post Top Light: 150W

(** marked is Make to Order)

*(Declared Lumens at 4000K at Highest Wattage)

Havells Up & Down Wall Sconce add unmatched elegance to your outdoor space with their contemporary design and lighting. It is available in seven lighting colors for easy customization.

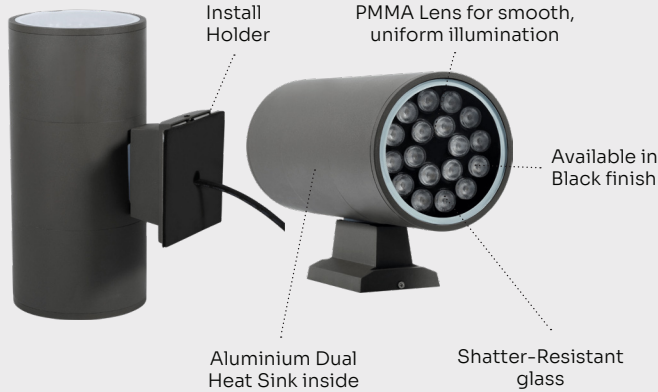

FEATURES

- It has an in-built installation holder for added ease
- Thermal conductive silicone for better heat dissipation
- Suitable for -40°C to +50°C temperatures
- Long 50,000-hour lifespan

WATTAGE	DIMENSIONS(DXH)
12W	4.25" x 7.87"
24W	4.25" x 11.81"

12W | 24W
 Wattages
 [W]

IP65
 Suitable for
 Wet Location

50,000 hours
 Rated
 Life

3 Year
 Product
 Warranty

PRODUCT SPECIFICATIONS

PRODUCT NUMBER	PRODUCT WATTAGE (W)	PRODUCT CCT (K)	INPUT VOLTAGE (V)	TYPE
KLH12W UP/DOWN RGB	12W	RGB	100-277 Vac	Up or Down
KLH12W UP/DOWN 4K	12W	4000K	100-277 Vac	Up or Down
KLH24W UP/DOWN RGB	24W	RGB	100-277 Vac	Up & Down
KLH24W UP/DOWN BLUE	24W	Blue	100-277 Vac	Up & Down
KLH24W UP/DOWN GREEN	24W	Green	100-277 Vac	Up & Down
KLH24W UP/DOWN 4K	24W	4000K	100-277 Vac	Up & Down
KLH24W UP/DOWN 6K	24W	6000K	100-277 Vac	Up & Down



LED CORN LAMP



The LED Corn Lamps Series delivers efficient, omni-directional light to replace HID and CFL lamps, with selectable CCT & Wattage, robust thermal design, and universal 100–277VAC operation for reliable performance in various fixtures.

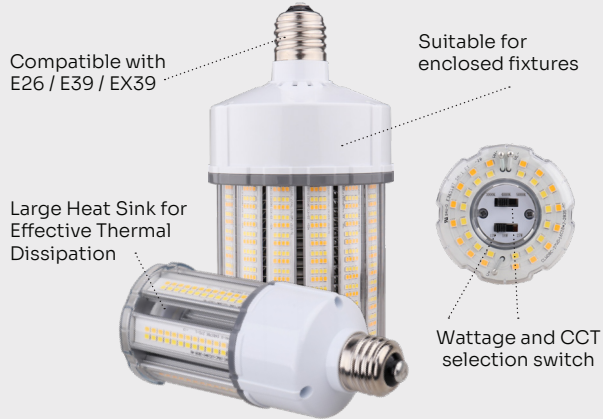

FEATURES

- High efficacy with 300W light delivers 40,500 lumens
- Fully selectable wattage and color temperature
- E26, E39, and EX39 base options
- Operates between -40°C to +50°C

WATTAGE	DIMENSIONS(DXH)	WATTAGE	DIMENSIONS(DXH)
18W	2.36" x 5.82"	120W	5.11" x 11.14"
27W	2.36" x 7.32"	200W	5.51" x 10.39"
54W	3.34" x 9.84"	300W	5.51" x 12.28"

Up to 40,500lm
Lumens (lm)

18W-300W
Wattages (W)

0-10V
Dimming Capabilities

IP64
Suitable for Wet Location

50,000 hours
Rated Life

5 Year
Product Warranty

PRODUCT SPECIFICATIONS

PRODUCT NUMBER	SELECTABLE WATTAGE [W]	SYSTEM LUMENS [LM]	LUMENS EFFICACY [LM/W]	SELECTABLE CCT [K]	INPUT VOLTAGE [V]
HL-CLP-MCCT-18W	18W	2,790lm	155 lm/W	3000K/4000K/5000K	120-277 Vac
HL-CLP-MW-MCCT-27W	12W/18W/27W	3,699lm	137 lm/W	3000K/4000K/5000K	120-277 Vac
HL-CLP-MW-MCCT-54W KLSN-CLW08C-054W	36W/45W/54W	7,614lm	141 lm/W	3000K/4000K/5000K	120-277 Vac
HL-CLP-MW-MCCT-120W KLSN-CLW08C-120W	80W/100W/120W	16,440lm	137 lm/W	3000K/4000K/5000K	120-277 Vac
HL-CLP-MW-MCCT-200W	160W/180W/200W	27,000lm	135 lm/W	3000K/4000K/5000K	120-277 Vac
HL-CLP-MW-MCCT-300W	220W/260W/300W	40,500lm	135 lm/W	3000K/4000K/5000K	120-277 Vac

*MCCT model codes feature selectable CCT options, and MW model codes offer selectable wattage options.

*Single-wattage model have no dimming capabilities.

Additional Accessories: E39 to E26 Connector (HL-CLP-E39 to E26-CN), and E26 to E39 Connector (HL-CLP-E26 to E39-CN).



FLEXI SPORT LIGHT



Flexi Sport Light combines power, flexibility, and efficiency in one high-performance fixture. It allows wattage selection up to 1400W, giving you control over energy use and light levels. The adjustable beam angle from 20° to 60° allows accurate light placement for improved field visibility.

Selectable multiple distributions 30°/40°/50°/60°

Selectable multiple distributions 20° (Optional:40°)



Selectable Beam



Superior brightness

Available in Bronze finish

FEATURES

- 1200W model delivers up to 225,400 lumens with high efficacy
- Selectable color temperature and beam angle*
- Available in high & low voltage options
- Suitable for -40°C to +50°C temperatures

WATTAGE	DIMENSIONS(LXWXH)
500W	14.4" × 17.0" × 16.1"
750W	15.3" × 19.7" × 19.1"
1400W	31.4" × 23.1" × 21.3"



Up to 225,400lm
Lumens (lm)



300W-1400W
Wattages (W)



0-10V
Dimming Capabilities



IP65
Suitable for Wet Location



50,000 hours
Rated Life



5 Year
Product Warranty

PRODUCT SPECIFICATIONS

	SELECTABLE WATTAGE	SYSTEM LUMENS	LUMENS EFFICACY	PRODUCT CCT	INPUT VOLTAGE
PRODUCT NUMBER	[W]	[LM]	[LM/W]	[K]	[V]
HL-SL-MW-ML3-500W	300W/400W/500W	85,000lm	170 lm/W	4000K 5000K 5700K	120-277 Vac
HL-SL-MW-ML4-750W	600W/700W/750W	127,500lm	170 lm/W	4000K 5000K 5700K	120-277 Vac
HL-SL-MW-1200W	1000W/1200W/1400W	225,400lm	161 lm/W	4000K 5000K 5700K	120-277 Vac
HL-SL-MW-ML3-500W-HV	300W/400W/500W	85,000lm	170 lm/W	4000K 5000K 5700K	277-480 Vac
HL-SL-MW-ML3-750W-HV	600W/700W/750W	127,500lm	170 lm/W	4000K 5000K 5700K	277-480 Vac
HL-SL-MW-1200W-HV	1000W/1200W/1400W	225,400lm	161 lm/W	4000K 5000K 5700K	277-480 Vac

Additional Accessories: Slipfitter Bracket (HL-SL-Slip fitter), Zhaga Socket (HL-SL-Zhaga Socket), Louver 500W (HL-SL-Louver 500W), Louver 750W (HL-SL-Louver 750W), Louver 1400W (HL-SL-Louver 1400W), Diving Version Bracket (HL-SL-Diving Version Bracket), Laser Pen (without battery) (HL-SL-Laser Pen without battery), 35FT External Cable (HL-SL-35FT EC), 50FT External Cable (HL-SL-50FT EC), 65FT External Cable (HL-SL-65FT EC), 80FT External Cable (HL-SL-80FT EC), 100FT External Cable (HL-SL-100FT EC), 10kV Junction Box, for 8 pcs driver, 120-277Vac (HL-SL-Junction Box 8pcs-120-277V), 10kV Junction Box for 8 pcs driver 200-480Vac (HL-SL-Junction Box 8pcs-200-480V), 10kV Junction Box for 6 pcs driver 120-277Vac (HL-SL-Junction Box 6pcs-120-277V) and 10kV Junction Box for 6 pcs driver AC200-480V (HL-SL-Junction Box 6pcs-200-480V).

*(Declared Lumens at 5000K at Highest Wattage)



INTERCHANGEABLE BOLLARD



Havells lighting's Bollards are your first choice for garden lighting projects. 3 IN 1 switch is selectable for CCT, wattage, and photocell ON/OFF control. Photocell can automatically turn off at sunrise or during the day, and automatically light up at sunset or night.



FEATURES

- Adjustable CCT and wattage allow for precise lighting control
- Comes with inbuilt photocell
- Operating Temperature: -40°C to +45°C
- Rated for 50,000 hours, offering a 5 year warranty

Available in two base sizes: 36" and 42"

Up to 3,300lm	14W/19W/24W	0-10V	IP65	50,000 hours	5 Year
Lumens (lm)	Wattages (W)	Dimming Capabilities	Suitable for Wet Location	Rated Life	Product Warranty

PRODUCT SPECIFICATIONS

PRODUCT NUMBER	SELECTABLE WATTAGE [W]	SYSTEM LUMENS [LM]	LUMENS EFFICACY [LM/W]	SELECTABLE CCT [K]	INPUT VOLTAGE [V]	TOP SHAPE
HL-BL-MW-MCCT-26W-DC	14W/19W/24W	3,300lm	140 lm/W	3000K/4000K/5000K	120-277 Vac	Dome
HL-BL-MW-MCCT-26W-CR	14W/19W/24W	2,800lm	120 lm/W	3000K/4000K/5000K	120-277 Vac	Corn Reflector

BASE SIZE

PRODUCT NUMBER	[INCH]
HL-BL-BASE-36"	36"
HL-BL-BASE-42"	42"

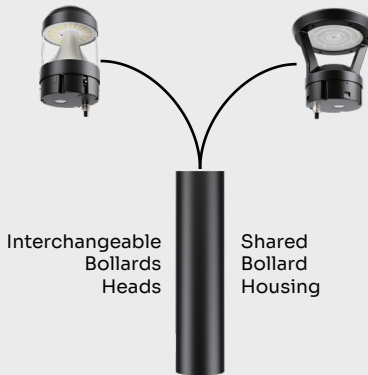

*(Declared Lumens at 5000K at Highest Wattage)

DOMED ALUMINUM BOLLARD



The Domed Aluminum Bollard features corrosion-resistant extruded and cast aluminum construction with a durable 1/4" wall thickness for long-lasting outdoor performance. Available in black and bronze finishes, it provides smooth, wide illumination through opal lens or parabolic reflector options.

FEATURES

- Corrosion-resistant extruded and cast aluminum with 1/4" wall thickness
- Opal lens or parabolic reflector options for smooth, wide light distribution
- 350mA driven LEDs with 70CRI, available in 3000K, 4000K, and 5000K
- UL-listed driver with 4kV internal and optional 10kV-20kV surge protection



PRODUCT CODE	PRODUCT WATTAGE	PRODUCT CCT	OPTICS	INPUT VOLTAGE
HL-BF-BDA8-WA-26W-XX-C	26W	3000K 4000K 5000K	Opal Acrylic	120-277 Vac
HL-BF-BDA8-PR-26W-XX-C	26W	3000K 4000K 5000K	Parabolic Reflector	120-277 Vac
HL-BF-BDA6-WA-26W-XX-C	26W	3000K 4000K 5000K	Opal Acrylic	120-277 Vac
HL-BF-BDA6-PR-26W-XX-C	26W	3000K 4000K 5000K	Parabolic Reflector	120-277 Vac

Also available: optional heights of 30" and 36"
 *XX=3000K or 4000K or 5000K (Color Temperature)
 *C=Country of Origin (U=USA & I=India)

PRODUCT CODE	DIMENSIONS (LXWXH)
HL-BF-BDA6	6" x 6" x 42"
HL-BF-BDA8	8" x 8" x 42"

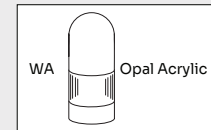
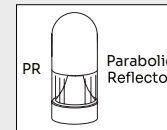
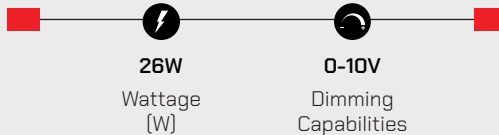

SQUARE ALUMINUM BOLLARD



The Square Aluminum Bollard is built from corrosion-resistant extruded and cast aluminum with a durable 1/4" wall thickness. Available in black and bronze finishes, it provides smooth, wide illumination through opal lens or parabolic reflector options.

FEATURES

- Corrosion-resistant extruded and cast aluminum with 1/4" wall thickness
- Opal lens or parabolic reflector options for smooth, wide light distribution
- LEDs driven at 350mA with 70 CRI, available in 3000K, 4000K, and 5000K
- UL-listed driver with 4kV internal and optional 10kV-20kV surge protection



PRODUCT CODE	PRODUCT WATTAGE	PRODUCT CCT	OPTICS	INPUT VOLTAGE
HL-BF-BDS8-WA-26W-XX-C	26W	3000K 4000K 5000K	Opal Acrylic	120-277 Vac
HL-BF-BDS8-PR-26W-XX-C	26W	3000K 4000K 5000K	Parabolic Reflector	120-277 Vac
HL-BF-BDS6-WA-26W-XX-C	26W	3000K 4000K 5000K	Opal Acrylic	120-277 Vac
HL-BF-BDS6-PR-26W-XX-C	26W	3000K 4000K 5000K	Parabolic Reflector	120-277 Vac

Also available: optional heights of 30" and 36"
 *XX=3000K or 4000K or 5000K (Color Temperature)
 *C=Country of Origin (U=USA & I=India)

PRODUCT CODE	DIMENSIONS (LXWXH)
HL-BF-BDS6	6" x 6" x 42"
HL-BF-BDS8	8" x 8" x 42"

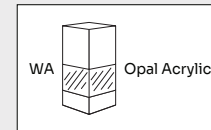
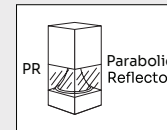
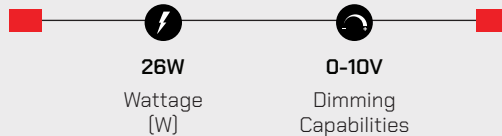



HAVELLS

**DEPENDABILITY STARTS WITH THE
RIGHT CONNECTION**



POLES & BRACKETS

Square Steel Base Mount Pole	94
Square Steel Direct Bury Pole	95
Round Non-Tapered Steel Pole.....	96
Round Non-Tapered Aluminum Pole	97
Round Tapered Aluminum Pole.....	98
Square Non-Tapered Aluminum Pole.....	99
Tenons.....	100
Tenon Reducers.....	101
Reducers	102
Bullhorns.....	103
RSR Brackets	104
Spoke Brackets.....	105
Sweep Bracket.....	106
Sports Lighting Brackets.....	107

SQUARE STEEL BASE MOUNT POLE



The Straight Square Steel Base Mount poles are built from high strength steel tubing and are available side drilled for arm mounted area lighting luminaires, or with tenon mounts for flood and post top luminaires.

FEATURES

- Four-sided, pre-drilled poles
- Flexible bolt-circle diameter options
- Handhole with grounding lug and removable cover
- Hot dipped galvanized anchor bolts
- Anchor bolt templates included
- Pre-ship anchor option available

PRODUCT CODE	MOUNTING TYPE	SHAFT SIZE	MOUNTING HEIGHT	GAUGE
HL-SQPL-BM-4"X15'-XX-X	Base Mount	4" Square	15 FEET	11G
HL-SQPL-BM-4"X18'-XX-X	Base Mount	4" Square	18 FEET	11G
HL-SQPL-BM-4"X20'-XX-X	Base Mount	4" Square	20 FEET	11G
HL-SQPL-BM-4"X25'-XX-X	Base Mount	4" Square	25 FEET	11G
HL-SQPL-BM-4"X30'-XX-X	Base Mount	4" Square	30 FEET	11 G

*XX=BR(Bronze) or BL(Black), X=W(Pre-wired) or Blank(without wire).

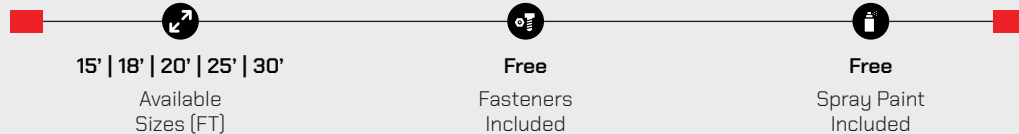

SQUARE STEEL DIRECT BURY POLE

The Straight Square Steel Direct Bury poles are built from high strength steel tubing and are available side drilled for arm mounted area lighting luminaires, or with tenon mounts for flood and post top luminaires.

FEATURES

- Four-sided, pre-drilled poles
- Reinforced handhole with grounding lug and removable cover
- Comes with a top cover and hand-hole cover
- Includes a spray bottle

PRODUCT CODE	MOUNTING TYPE	SHAFT SIZE	MOUNTING HEIGHT	GAUGE
HL-SQPL-DB-4"X15'-XX-X	Direct Bury	4" Square	15 FEET	11G
HL-SQPL-DB-4"X20'-XX-X	Direct Bury	4" Square	20 FEET	11G
HL-SQPL-DB-4"X25'-XX-X	Direct Bury	4" Square	25 FEET	11G
HL-SQPL-DB-4"X30'-XX-X	Direct Bury	4" Square	30 FEET	11G

*XX=BR(Bronze) or BL(Black), X=W(Pre-wired) or Blank(without wire).

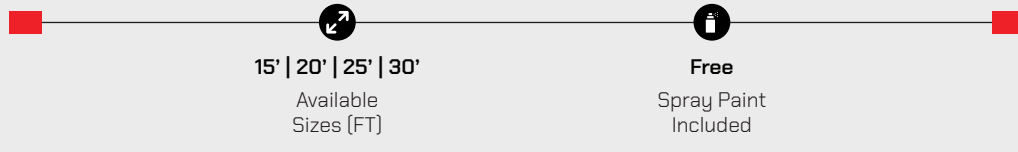

ROUND NON-TAPERED STEEL POLE

The Round Non-Tapered Steel Base Mount Poles are fabricated from high-strength structural steel tubing and are available with standard drilling patterns or tenon mounts for use with area, flood, and post-top luminaires.

FEATURES

- Structurally engineered steel shaft meeting ASTM-A501 standards
- Reinforced handhole assembly with grounding lug and secure cover
- Precision-welded base plate with slotted holes for installation tolerance
- Fully galvanized anchor bolts supplied with nuts and washers
- TGIC powder-coat finish over multi-stage pretreatment for long-term durability

PRODUCT CODE	MOUNTING TYPE	SHAFT SIZE	MOUNTING HEIGHT	GAUGE
HL-RNTS-XX4-YY-C	Base Mount	4" Round	10 FEET - 24 FEET	7G 11G
HL-RNTS-XX5-YY-C	Base Mount	5" Round	16 FEET - 25 FEET	7G 11G
HL-RNTS-XX6-7-C	Base Mount	6" Round	18 FEET - 25 FEET	7G

*XX=Mounting Height (10' | 12' | 14' | 16' | 18' | 20' | 24' | 25')

*YY=Gauge (7" | 11")

*C=Country of Origin (U=USA & I=India)

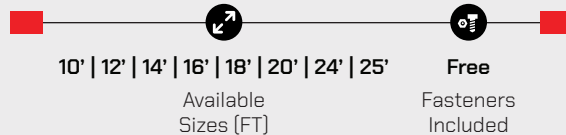

ROUND NON-TAPERED

ALUMINUM POLE

The Round Non-Tapered Aluminum Base Mount Poles use 6063-T6 aluminum for corrosion-resistant performance and feature cast bases and optional tenon mounts for flexible installations.

FEATURES

- Precision-extruded 6063-T6 aluminum shaft with reinforced handhole and cover
- Cast aluminum base plate engineered with heavy-wall vertical gussets for superior strength
- Removable pole cap and custom drilling options for field-matched mounting configurations
- Fully galvanized steel anchor bolts supplied with nuts and washers
- Premium TGIC powder-coat finish applied over multi-stage pretreatment for long-term durability

PRODUCT CODE	MOUNTING TYPE	SHAFT SIZE	MOUNTING HEIGHT	WALL THICKNESS
HL-RNTA-XX4-125-C	Base Mount	4" Round	8 FEET – 14 FEET	0.125"
HL-RNTA-XX5-YY-C	Base Mount	5" Round	10 FEET – 20 FEET	0.125" / 0.188"
HL-RNTA-XX6-YY-C	Base Mount	6" Round	18 FEET – 20 FEET	0.125" / 0.188"
HL-RNTA-XX658-YY-C	Base Mount	6½" Round	20 FEET – 25 FEET	0.188" / 0.250"

*XX = Mounting Height (8' | 10' | 12' | 14' | 16' | 18' | 20' | 25')

*YY = Wall Thickness (125 = 0.125" | 188 = 0.188" | 250 = 0.250")

*C=Country of Origin (U=USA & I=India)

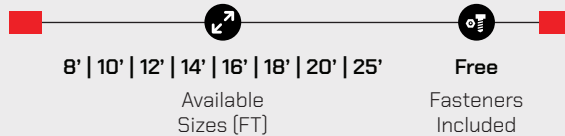

ROUND TAPERED

ALUMINUM POLE

These Round Tapered Aluminum Poles use high-strength 6063-T6 aluminum and feature a precision-spun tapered shaft, heavy-duty cast base, and durable TGIC powder-coat finish for reliable outdoor lighting.

FEATURES

- Spun-tapered 6063-T6 aluminum alloy for high strength and corrosion resistance
- Reinforced cast aluminum with vertical gussets for stability
- Includes galvanized anchor bolts, nuts, and washers
- Tamper-resistant hand hole with stainless steel hardware
- Durable TGIC polyester powder coat over multi-stage pretreatment

PRODUCT CODE	MOUNTING TYPE	SHAFT SIZE (BOTTOM-TOP)	MOUNTING HEIGHT	WALL THICKNESS
HL-RTA-XX43-125-C	Base Mount	4" » 3" Taper	14 FEET - 16 FEET	0.125"
HL-RTA-XX53-188-C	Base Mount	5" » 3" Taper	18 FEET	0.125" / 0.188"
HL-RTA-XX64-188-C	Base Mount	6" » 4" Taper	20 FEET	0.125" / 0.188"
HL-RTA-XX74-188-C	Base Mount	7" » 4" Taper	25 FEET	0.188" / 0.250"

*XX = Mounting Height (14' | 16' | 18' | 20' | 25')

*C=Country of Origin (U=USA & I=India)

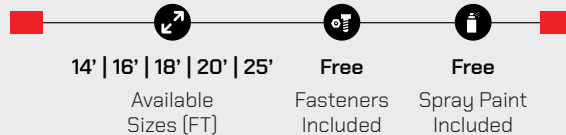

SQUARE NON-TAPERED

ALUMINUM POLE

These Square Non-Tapered Aluminum Poles use high-strength 6063-T6 aluminum and feature a cast base, reinforced hand hole, and durable TGIC powder-coat finish for reliable outdoor performance.

FEATURES

- High-strength 6063-T6 aluminum construction for corrosion resistance
- Reinforced cast-aluminum base engineered for stability
- Includes galvanized anchor bolts, nuts, and washers
- Tamper-resistant hand hole with stainless-steel hardware
- Durable TGIC polyester powder coating for long-term protection

PRODUCT CODE	MOUNTING TYPE	SHAFT SIZE	MOUNTING HEIGHT	WALL THICKNESS
HL-SNTA-XX4-YY-C	Base Mount	4" Square	8 FT – 20 FT	0.125" 0.188"
HL-SNTA-XX5-YY-C	Base Mount	5" Square	12 FT – 25 FT	0.125" 0.188"
HL-SNTA-XX6-YY-C	Base Mount	6" Square	20 FT – 25 FT	0.188" 0.250"

*XX=Mounting Height (10'|12'|14'|16'|18'|20'|24'|25')

*YY = Wall Thickness (125 = 0.125" | 188 = 0.188" | 250 = 0.250")

*C=Country of Origin (U=USA & I=India)

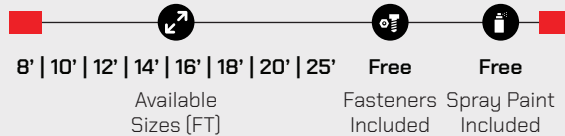

TENONS

STRAIGHT TENON



PRODUCT CODE	PRODUCT NAME	CONSTRUCTION	FINISH	PIPE THICKNESS
HL-TN-SQ-BLACK	Tenon Mount Square Pole	Steel	Black	11 Gauge
HL-TN-SQ-BZ	Tenon Mount Square Pole	Steel	Bronze	11 Gauge

ANGULAR WALL MOUNT TENON

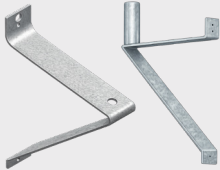

PRODUCT CODE	PRODUCT NAME	CONSTRUCTION	FINISH	PIPE THICKNESS
HL-TN-SAWN	Tenon Angular Wall Mount	Steel	Galvanized	11 Gauge
HL-TN-SAWMT	Steel Angular Wall Mount With 2 3/8" Tenon	Steel	Galvanized	11 Gauge

TENON MOUNT



PRODUCT CODE	PRODUCT NAME	CONSTRUCTION	FINISH	PIPE THICKNESS
HL-TN-90	Tenon Mount 90 Degree Square Pole	Steel	Bronze	11 Gauge
HL-TN-R	Tenon Mount Round Pole	Steel	Bronze	11 Gauge
HL-WT	Wood Tenon	Steel	Bronze	11 Gauge

TENON REDUCERS

REDUCER ROUND POLE



PRODUCT CODE	PRODUCT NAME	CONSTRUCTION	FINISH	PIPE THICKNESS
HL-RD-3"-R-SO	Reducer 3" Round Pole	Steel	Bronze	11 Gauge
HL-RD-4"-R-SO	Reducer 4" Round Pole	Steel	Bronze	11 Gauge
HL-RD-5"-R-SO	Reducer 5" Round Pole	Steel	Bronze	11 Gauge
HL-RD-6"-R-SO	Reducer 6" Round Pole	Steel	Bronze	11 Gauge

REDUCER SQUARE POLE (SLIP IN)



PRODUCT CODE	PRODUCT NAME	CONSTRUCTION	FINISH	PIPE THICKNESS
HL-RD-4"-SQ-SI	Reducer 4" Square Pole (Slip In)	Steel	Bronze	11 Gauge
HL-RD-5"-SQ-SI	Reducer 5" Square Pole (Slip In)	Steel	Bronze	11 Gauge
HL-RD-6"-SQ-SI	Reducer 6" Square Pole (Slip In)	Steel	Bronze	11 Gauge

REDUCERS

REDUCER SQUARE POLE SLIP IN 3 ARM

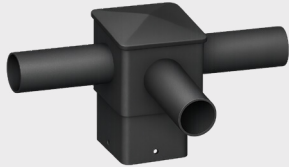

PRODUCT CODE	PRODUCT NAME	CONSTRUCTION	FINISH	PIPE THICKNESS
HL-RD-4"-SQ-3A-90-SI	Reducer 4" Square Pole Slip In 3 ARM	Steel	Bronze	11 Gauge
HL-RD-5"-SQ-3A-90-SI	Reducer 5" Square Pole Slip In 3 ARM	Steel	Bronze	11 Gauge

REDUCER SQUARE POLE SLIP IN 4 ARM

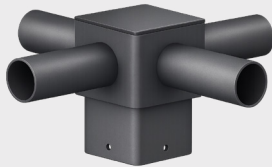

PRODUCT CODE	PRODUCT NAME	CONSTRUCTION	FINISH	PIPE THICKNESS
HL-RD-4"-SQ-4A-90-SI	Reducer 4" Square Pole Slip In 4 ARM	Steel	Bronze	11 Gauge
HL-RD-5"-SQ-4A-90-SI	Reducer 5" Square Pole Slip In 4 ARM	Steel	Bronze	11 Gauge

BULLHORNS

BULLHORN ROUND-ROUND



PRODUCT CODE	PRODUCT NAME	CONSTRUCTION	FINISH	PIPE THICKNESS
HL-BH-3-RR-120	Bullhorn 3 ARM Round-Round-120 Degree	Steel	Bronze	11 Gauge
HL-BH-4-RR-90	Bullhorn 4 ARM Round-Round-90 Degree	Steel	Bronze	11 Gauge

BULLHORN ROUND ROUND-INLINE



PRODUCT CODE	PRODUCT NAME	CONSTRUCTION	FINISH	PIPE THICKNESS
HL-BH-2-RRI	Bullhorn 2 ARM Round-Round-Inline	Steel	Bronze	11 Gauge
HL-BH-3-RRI	Bullhorn 3 ARM Round-Round-Inline	Steel	Bronze	11 Gauge
HL-BH-4-RRI	Bullhorn 4 ARM Round-Round-Inline	Steel	Bronze	11 Gauge

RSR BRACKETS

ROUND SQUARE ROUND IN LINE BRACKET



PRODUCT CODE	PRODUCT NAME	CONSTRUCTION	FINISH	PIPE THICKNESS
HL-BH-2-RSR	2 ARM RSR Bracket Inline	Steel	Bronze	11 Gauge
HL-BH-3-RSR	3 ARM RSR Bracket Inline	Steel	Bronze	11 Gauge
HL-BH-4-RSR	4 ARM RSR Bracket Inline	Steel	Bronze	11 Gauge



PRODUCT CODE	PRODUCT NAME	CONSTRUCTION	FINISH	PIPE THICKNESS
HL-BH-3-120-RSR	3 ARM RSR Bracket 120 Degree	Steel	Bronze	11 Gauge
HL-BH-4-90-RSR	4 ARM RSR Bracket 90 Degree	Steel	Bronze	11 Gauge

ROUND SQUARE ROUND

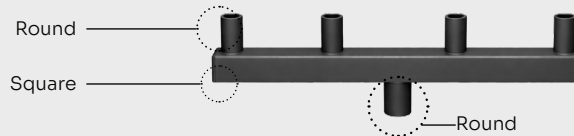

SPOKE BRACKET

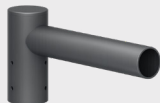

PRODUCT CODE	PRODUCT NAME	CONSTRUCTION	FINISH	PIPE THICKNESS
HL-SP-1	Spoke Bracket 1 Arm	Steel	Bronze	11 Gauge

SPOKE BRACKET 2 LIGHT



PRODUCT CODE	PRODUCT NAME	CONSTRUCTION	FINISH	PIPE THICKNESS
HL-SP-2-90	Spoke Bracket 2 Arm/90 Degree	Steel	Bronze	11 Gauge
HL-SP-2-180	Spoke Bracket 2 Arm/180 Degree	Steel	Bronze	11 Gauge

SPOKE BRACKET 3 LIGHT



PRODUCT CODE	PRODUCT NAME	CONSTRUCTION	FINISH	PIPE THICKNESS
HL-SP-3-90	Spoke Bracket 3 Arm/90 Degree	Steel	Bronze	11 Gauge
HL-SP-3-120	Spoke Bracket 3 Arm/120 Degree	Steel	Bronze	11 Gauge

SPOKE BRACKET 4 LIGHT

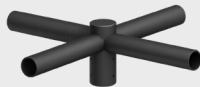

PRODUCT CODE	PRODUCT NAME	CONSTRUCTION	FINISH	PIPE THICKNESS
HL-SP-4-90	Spoke Bracket 4 Arm/90 Degree	Steel	Bronze	11 Gauge

SWEEP BRACKET

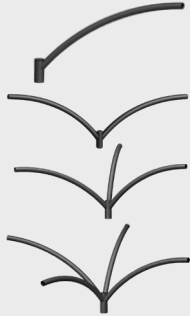

PRODUCT CODE	PRODUCT NAME	CONSTRUCTION	FINISH	PIPE THICKNESS
HL-SW-1-4'	Sweep Bracket 1-Arm 4ft	Steel	Bronze	11 Gauge
HL-SW-2-180-4'	Sweep Bracket 2 Arm/ 180 Degree 4ft	Steel	Bronze	11 Gauge
HL-SW-3-120-4'	Sweep Bracket 3 Arm/ 120 Degree 4ft	Steel	Bronze	11 Gauge
HL-SW-4-90-4'	Sweep Bracket 4 Arm/ 90 Degree 4ft	Steel	Bronze	11 Gauge

*Custom Arm length available

SPORTS LIGHTING BRACKETS

PRODUCT CODE	PRODUCT NAME	CONSTRUCTION	FINISH
HL-SB-2	2 Light Sports Light Pole Bracket	Steel	Galvanized
HL-SB-3	3 Light Sports Light Pole Bracket	Steel	Galvanized
HL-SB-4	4 Light Sports Light Pole Bracket	Steel	Galvanized
HL-SB-5	5 Light Sports Light Pole Bracket	Steel	Galvanized
HL-SB-6	6 Light Sports Light Pole Bracket	Steel	Galvanized

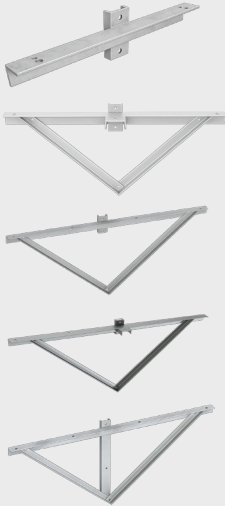



HAVELLS

**POWER YOUR SIGNAGE WITH LIGHTING THAT
DELIVERS CLARITY, CONSISTENCY, AND
CRAFTSMANSHIP**



| SIGNAGE

Rapid Lamp Gen 2.....	110
Rapid Lamp Gen Z.....	112
Rapid Bracket.....	113
4' T-cable extension wires.....	114
12" direct feed wire.....	115

RAPID LAMP GEN 2

This innovative LED retrofit solution is designed to upgrade any sign quickly and efficiently, regardless of size. Its patented technology delivers bright, uniform light output while reducing energy use and maintenance needs.

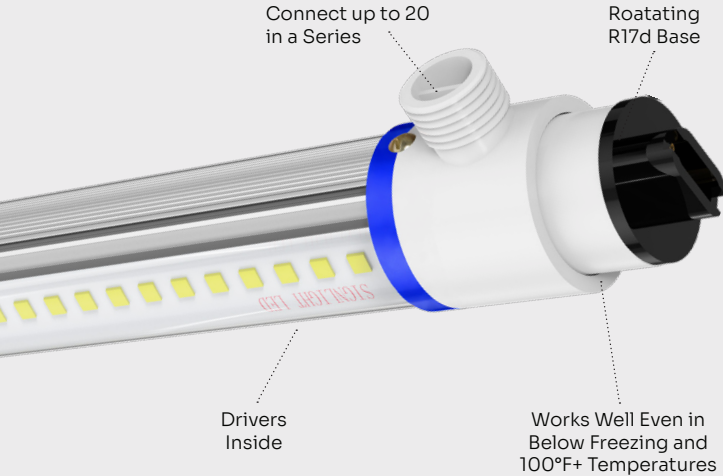

PATENTED LED LAMPS

AVAILABLE SIZES

- F18, F24, F30, F36, F42, F48, F60, F64, F72, F84, F96, F108, F117, F120.
- F108, F117, and F120 comes in two pieces.

Highly Efficient LED Lamps

Generation 2 Tubes are designed to retrofit any sign (any size) in approximately 30 minutes. A super bright, efficient led light with light output over 700lm/ft. Additionally, it consumes less energy and is maintenance free.



Install in less than 30 Mins



No External Driver needed



Double Sided Sign Tube



6000K Color Temperature



IP65 Wet Location



50,000 hours Rated Life



5 Year Warranty

PRODUCT SPECIFICATIONS

MODEL NAME	TUBE SIZE (FT)	PRODUCT WATTAGE (W)	SYSTEM LUMENS (LM)	PRODUCT CCT (K)
2SL07T10XX0450	F18	7W	910lm	6000K
2SL13T10XX0600	F24	13W	1,560lm	6000K
2SL13T10XX0750	F30	13W	1,690lm	6000K
2SL16T10XX0900	F36	16W	2,080lm	6000K
2SL21T10XX1050	F42	21W	2,700lm	6000K
2SL21T10XX1200	F48	21W	2,730lm	6000K
2SL28T10XX1500	F60	28W	3,640lm	6000K
2SL28T10XX1600	F64	38W	3,640lm	6000K
2SL38T10XX1800	F72	38W	4,750lm	6000K
2SL38T10XX2100	F84	38W	4,750lm	6000K
2SL51T10XX2475	F96	51W	6,630lm	6000K
2SL51T10XX2700	F108	51W	6,630lm	6000K
2SL60T10XX2925	F117	60W	8,450lm	6000K
2SL60T10XX3000	F120	60W	8,450lm	6000K

RAPID LAMP GEN Z

The Rapid Lamp Gen Z simplifies outdoor signage with a driver-free design and double-sided output, ensuring a flawless, shadow-free display. Built to perform in temperatures from freezing to over 100°F, it combines rugged IP65 durability with superior lighting excellence

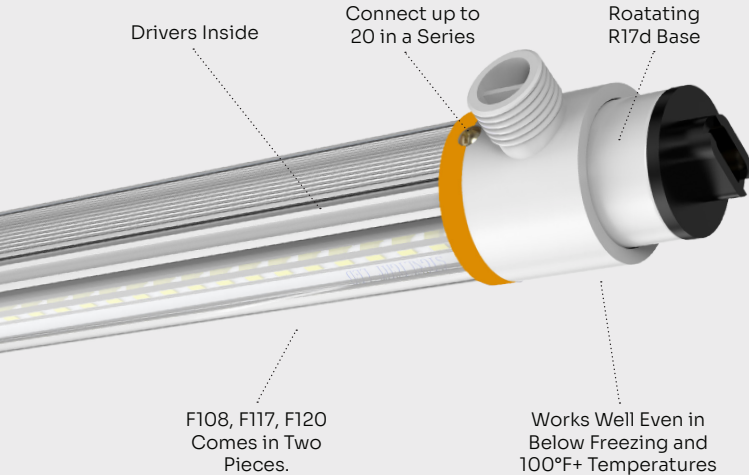







PATENTED LED LAMPS

AVAILABLE SIZES

- F18, F24, F30, F36, F42, F48, F60, F64, F72, F84, F96, F108, F117, F120
- The Rapid Lamp Gen Z for slim cabinets are available in a packs of 4 or 10.

Lighting Excellence: No More Hot Spots

Our Generation Z LED sign tubes, designed with a lens over the led to ensure even light distribution across sign cabinets, eliminating hot spots.

						
Install in less than 30 Mins	No External Driver needed	Double Sided Sign Tube	6000K Color Temperature	IP65 Wet Location	50,000 hours Rated Life	5 Year Warranty

PRODUCT SPECIFICATIONS

MODEL NAME	TUBE SIZE (FT)	PRODUCT WATTAGE (W)	SYSTEM LUMENS (LM)	PRODUCT CCT (K)
ZSL07T10XX0450	F18	7W	9,10lm	6000K
ZSL13T10XX0600	F24	13W	1,560lm	6000K
ZSL13T10XX0750	F30	13W	1,690lm	6000K
ZSL16T10XX0900	F36	16W	2,080lm	6000K
ZSL21T10XX1050	F42	21W	2,700lm	6000K
ZSL21T10XX1200	F48	21W	2730lm	6000K
ZSL28T10XX1500	F60	28W	3,640lm	6000K
ZSL28T10XX1600	F64	38W	3,640lm	6000K
ZSL38T10XX1800	F72	38W	4,750lm	6000K
ZSL38T10XX2100	F84	38W	4,750lm	6000K
ZSL51T10XX2475	F96	51W	6,630lm	6000K
ZSL51T10XX2700	F108	51W	6,630lm	6000K
ZSL60T10XX2925	F117	60W	8,450lm	6000K
ZSL60T10XX3000	F120	60W	8,450lm	6000K

RAPID BRACKET

Rapid mounting brackets come in multiple models, allowing you to install various sizes and types of LED tubes within the cabinet of a sign, made from polycarbonate for long life.

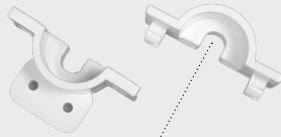

SIDE MOUNTING BRACKET

Side mounting brackets are installed at side panels inside the LED sign board cabinet. They are used to mount LED lights on side panels inside the cabinet.

Made from polycarbonate for long life



BACK MOUNTING BRACKET

Back mounting brackets can be used on the wall or ceiling, to add light and to light up tight spaces. This rapid bracket can be easily used in combination with rapid lamps to light up awnings, canopies, building facia or roof lines.

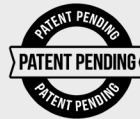
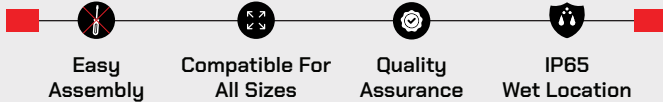

RAPID BRACKET GUIDE

TUBE SIZE	CASE QUANTITY	CLEARANCE NEED TO USE RAPID BRACKET IN CABINET
F18	10 pcs	16 1/4"
F24	10 pcs	22 1/4"
F30	10 pcs	28 1/4"
F36	10 pcs	34 1/4"
F42	10 pcs	40 1/4"
F48	10 pcs	46 1/4"
F60	10 pcs	58 1/4"
F64	10 pcs	62 1/4"
F72	10 pcs	70 1/4"
F84	10 pcs	82 1/4"
F96	10 pcs	94 1/4"
F108	10 pcs	106 1/8"
F117	10 pcs	115 1/8"
F120	10 pcs	118 1/8"

SIGN ACCESSORIES

4' T-CABLE EXTENSION WIRES



Our T-cable extension wires are specially designed to simplify connections between multiple lamps—especially in non-standard sign shapes—eliminating the need to start a new connection each time. These connectors streamline installation, remove guesswork from the process, and ensure uninterrupted illumination of your signboard.

12" DIRECT FEED WIRE



The 12-inch direct feed wire is designed for applications where only a single lamp is installed and T-connectors are not required for daisy-chaining, such as installations under awnings, building fascia, or canopies. It eliminates excess wiring and improves the overall aesthetics of the project.

RAPID LAMPS SPACING GUIDE

CABINET WIDTH	SUGGESTED TWO SIDED RAPID LAMP DISTANCE	CABINET	SUGGESTED LAMPS
4" - 6"	6" - 7"	Two face cabinet	Gen Z
8" - 10"	8"	Two face cabinet	Gen 2
Over 10"	12" - 13"	Two face cabinet	Gen 2
4" - 6"	5" - 6"	One face cabinet	Gen Z
8"	6"- 8"	One face cabinet	Gen 2 / Gen Z
3"	3"-5"	One face/ Two face cabinet	Gen Z



Easy Assembly



Compatible For All Sizes



Quality Assurance



IP65 Wet Location



Pricing Advantage



HAVELLS

EXIT

EXIT

**RELIABLE ILLUMINATION IN
EVERY CRITICAL MOMENT**



| EMERGENCY LIGHT

Switchable Emergency Exit Sign.....	118
Switchable Emergency Exit Sign Combo	119
Dual Head Emergency Light	120
Outdoor Remote Heads Emergency Light	121



SWITCHABLE EMERGENCY EXIT SIGN

PRODUCT CODE	INPUT CURRENT	INPUT WATT	LED TYPE	CHARGING TYPE	EMERGENCY RUN TIME
HL-EX-E	0.02A @ 120V 0.01A @ 277V	1.1W	7 Red LEDs + 6 Green LEDs	24 Hrs	90 Mins

Rated Voltage: 120-277V



SWITCHABLE EMERGENCY EXIT SIGN COMBO

PRODUCT CODE	INPUT CURRENT	INPUT WATT	LED TYPE	CHARGING TYPE	EMERGENCY RUN TIME
HL-EEM-E	0.04A	2.4W	(6) LEDs for red version/(6) LEDs for green version + (2) lamp heads	24 Hrs	90 Mins

Rated Voltage: 120-277V

DUAL HEAD EMERGENCY LIGHT



PRODUCT CODE	INPUT CURRENT	INPUT WATT	LED TYPE	CHARGING TYPE	EMERGENCY RUN TIME
HL-DHEM	0.02/0.01A	2.0W	2x12pcs ultra bright 2835 SMT LED lamp	24 Hrs	90 Mins

Rated Voltage: 120-277V

OUTDOOR REMOTE HEADS EMERGENCY LIGHT



PRODUCT CODE	INPUT WATT	LED TYPE	LUMEN OUTPUT	LAMP QUANTITY
HL-RHEM	Max 2.4W	2x12pcs 2835 SMD LED	200lm	2

Rated Voltage: 3.6-15V

| Fully Selectable Solutions

We provide Fully Selectable Solutions at Havells Lighting. Our selectable lighting solutions let you choose both the color temperature and wattage to suit any space, giving you flexibility, control, and efficiency all in one. Look for products labeled with these icons to find Fully Selectable Solutions.



2 CCT SELECTABLE

Switch between 4000K and 5000K color temperatures to create the environment of your choosing.



3 CCT SELECTABLE

Available in two variants:

- 3000K/4000K/5000K
- 3500K/4000K/5000K

Allows selection of the desired color temperature to match the atmosphere of your space.



5 CCT SELECTABLE

Available in Three variants:

- 2700K/3000K/3500K/4000K/5000K
- 3000K/3500K/4000K/4500K/5000K
- 3000K/3500K/4000K/4500K/6500K

Ensures consistent and flexible lighting across varied applications.



SELECTABLE BEAM

SELECTABLE BEAM

Choose between different beam angles and distribution patterns to control how light is delivered, meeting precise design and application needs.



WATTAGE SELECTABLE

Allows users to adjust the power and brightness level of the fixture according to their application requirements, ensuring optimal performance and energy efficiency.



| MARKETING MATERIALS & SALES TOOLS

The Havells Lighting Partner Portal provides essential resources for presenting products in a clear and effective manner, enabling users to make a positive impression on potential clients and drive sales growth. The portal offers a comprehensive selection of materials and tools, including:

- Before & After Photos
- LED Presentation
- Video Testimonials
- Price List
- Product Guide
- Spec Sheets

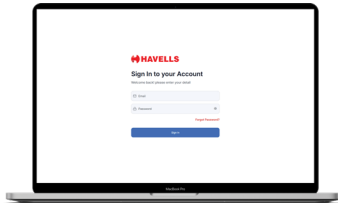

| TRAINING MATERIALS *Coming Soon*

Alongside marketing materials and sales tools, the Havells Lighting Partner Portal provides comprehensive training resources designed to strengthen both product knowl and service quality. Utilize these training materials to support employee development and enhance customer engagement.

Item	Qty	Unit	Price	Status
...
...

LIVE INVENTORY

Item	Description	Price	...
...
...

PRICING



PRODUCT GUIDE VIDEOS



HAVELLS LIGHTING LLC
111 Preamble Ct,
Anderson, SC-29621

T: 855-HAVELLS
E: salesusa@havells.com
W: www.havellslighting.com



@HAVELLSLIGHTINGLLC

All rights reserved. Havells Lighting LLC reserves the right to make changes to specifications and/or discontinue any product at anytime without the notice. Information presented in this document is reliable and accurate, It does not represent any quotation or contact. No liability will be accepted by the contributor by the publisher for any consequences for its use. Reproduction in whole or part is prohibited without prior consent of the copyright owner.